

Installation Operation & Maintenance (IOM) for 720-X Pressure reduction valve (double Chambered)



Introduction

The Bermad 720-X double chamber pressure reduction valve is a highly reactive pressure reduction valve that is designed to enable constant pressure downstream regardless of inlet pressure or flow. The double chamber design ensures no hydraulic lock out and full opening if required to minimise head loss.



Valve Details

The basic 700 series valve is configured as double chamber where the lower diaphragm is vented to atmosphere. It is critical for operation that this lower chamber is always vented and never blocked off.

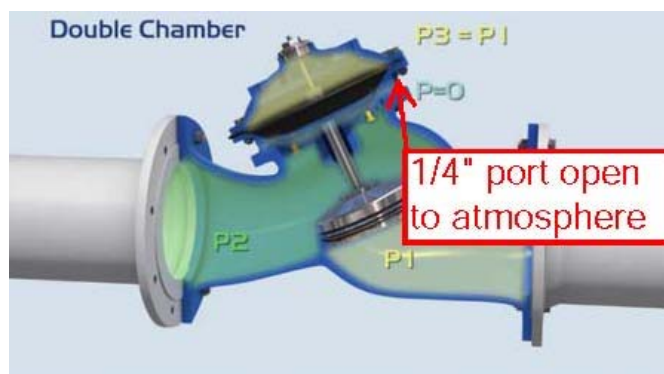

In order to minimise the minimum head loss in the valve the inner spring is removed. Typically the V port plug is used for regulation should the range of flows required is from zero upwards. If using the PRV for medium to higher flows only, the valve can be configured with a flat disc that increased the flow capacity slightly.

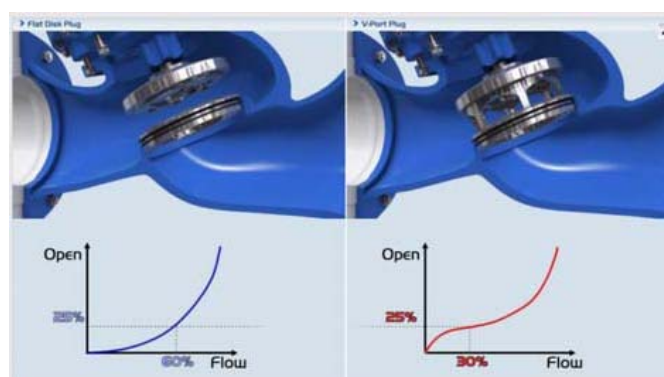

Pilot details

In the double chamber design there are several different designs of pilots available in order to achieve the pressure reduction function, each with different characteristics. The pilots are all three-way positioning pilots sensing the pressure on the downstream side. Some details of these pilots are as follows :

#X-R-16 three way positioning pilot

This pilot is brass and has a larger flow path to enable very fast operation if required on closing if required. It has an inbuilt needle valve to control opening speed should it be required.

Spring range for regulation : 1-16 bar

Inlet pressure rating : 25 bar

Material Brass

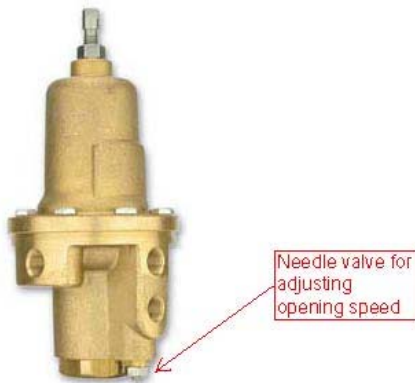

PCX-A-M (Sharp) three way positioning pilot

This pilot is brass and is used where reaction speed is not quite so critical and greater accuracy of control is required. If opening speed adjustability is required, an external needle valve is fitted to port 2.

Inlet pressure rating : 16 bar

Material : Brass

Spring ranges for regulation :

Spring	Spring color	Range (bar)
J	Green	0.2-1.7
K	Grey	0.5-3.0
N	Natural	0.8-6.5
V	Blue &	1-10
P	White	1-16



Pilot details ctd/

#8 large diameter three-way positioning pilot

This pilot is used when you need fast acting but extremely accuracy on regulation with a tolerance of plus or minus 0.4m. It has the inbuilt needle valve similar to the X-R-16 brass pilot to control opening speed.

Spring range for regulation : M6 (2-14m), M5 (5-22m), M4 (15-35m), M8 (25-70m)

Pressure rating : 16 bar

Material : Brass or stainless steel.



Installation

There are many different things that are important when considering installation of the following valve, so we suggest the following in considered prior to installation:

1. Make sure the pipe upstream has been fully flushed to clear any pipeline debris that may get stuck in the inside of the valve
2. Make sure the weight of the valve is properly supported to ensure there is no flex in the system.
3. Make sure there is sufficient room either side of the valve to enable maintenance of the valve. Also make sure there is sufficient room above the valve to remove the actuator when it is required.
4. Install isolation valves close to the valve to enable internal service of the valve. If necessary, install a by-pass around the valve to continue flow while servicing the valve. If critical that there is not increase in pressure, then fit a smaller by-pass PRV in parallel and or a pressure relief valve set 5m above the set point of the reducing valve.
5. The valve orientation can be configured in many directions including vertical, horizontal, but not upside down as you cannot vent the air from the control chamber correctly. **Note : Valves are plumbed for horizontal installation from the factory unless specified when ordering. Make sure if the valve is being installed anything other than horizontal, you make the factory aware so they can plumb and configure the valve so there is never any air in the control chamber.**
6. If there are going to be high spots downstream of the valve where air cannot be released, contact Bermad for advice on the correct air release valve to be installed.
7. If the pipeline is subject or at risk of having larger solids present in the water, then install a Bermad 70F strainer prior to the PRV.

Note

If ever in doubt about the design of the station, contact your nearest Bermad office for advice on how best to configure the station for optimum performance



Commissioning

We suggest the following be considered prior to any commissioning of the PRV

1. Make sure the valve is safely supported and that the installation is easy and safe to operate
2. Flush any debris out of the pipe prior to the PRV to discard any debris in the pipe.
3. Turn adjustment bolt for pilot anti-clockwise fully with no tension.
4. Open inlet isolation valve on valve (1) inlet and (2) outlet to the pilot
5. Relax a fitting at the highest point on the valve to release air from the cover of the valve.
6. Open a small valve downstream of the PRV to induce a small amount of flow
7. Start to turn the adjustment bolt on the pilot clockwise (no more than $\frac{1}{4}$ of a turn at a time) and watch the valve open. When the valve opens, a small amount of water will vent from the side port to open the valve. Do not continue to turn the bolt until the water has stopped venting.
8. Continue to turn incrementally with delays until the desired pressure is reached. If operating at extremely low flows, the vent line may have to be slowed down by closing down the needle valve (21) clockwise. Tighten locknut to complete.

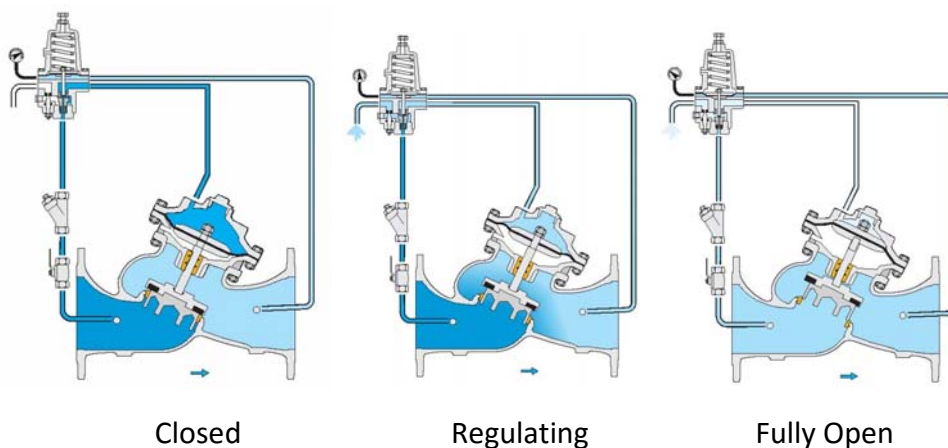
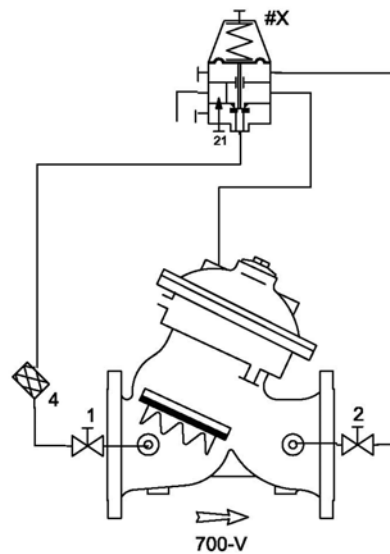

Maintenance

We suggest the following maintenance is carried out to ensure the valve is operating as designed.

6 Monthly

- Clean inlet strainer (#4)
- Check function of PRV by altering inlet flow or pressure to see that the valve remains stable.
- Check the pressure gauge is functioning as designed
- Make sure the port on the under side of the diaphragm open to atmosphere is always fully opened and not blocked.

12 Monthly

- All of the items on 6 monthly list
- Flush control chamber completely to remove any debris in the control chamber
- Close needle valve on pilot and re-open to the same set point to dislodge any debris on the seat

5 yearly

- All of the items in 12 monthly service
- Remove the actuator and check the internal for any wear on the seat, body or seal disc seal of the valve.

10 Yearly

- All of the items in 5 yearly service
- Install a full service kit in the pilot and valve.

Note : If in any doubt as always contact your nearest Bermad Sales office.



Trouble Shooting

Valve fails too open

- The needle valve is blocked. Close fully and back off to same set point.
- The valve is already fully open so the inlet pressure is almost equal to the downstream pressure. Check the inlet pressure range typically of the PRV.
- The set point of the pilot adjustment bolt is not correct. Increase clockwise at $\frac{1}{4}$ of a turn at a time until the valve opens and is stable at the correct set point.
- The outlet pressure is greater than the inlet pressure and the valve is remaining closed as it is a non-return valve. Check inlet pressures.
- Check ball valves 1 and 2 are fully open and not blocked.

Valve fails too close

- The inlet strainer (#4) is blocked. Isolate and clean.
- An object is under the main valve body keeping the body from closing. Isolate the valve and remove the actuator to clean the debris out.
- The adjustment bolt on the pilot is wound fully clockwise to make the valve go fully open. Check the adjustment bolt on pilot setting.
- Check ball valves 1 and 2 are fully open and not blocked.

Valve is oscillating on pressure set point.

- The needle valve is blocked. Close fully and back off to same set point.
- Check ball valves 1 and 2 are fully open and not blocked.
- There is an air pocket either upstream or downstream of the PRV that is causing the air pocket to collapse and expand. Release air or fit correct air release valves to rectify

Note : If in any doubt, call the Bermad nearest sales office for advice





Large Control Filter

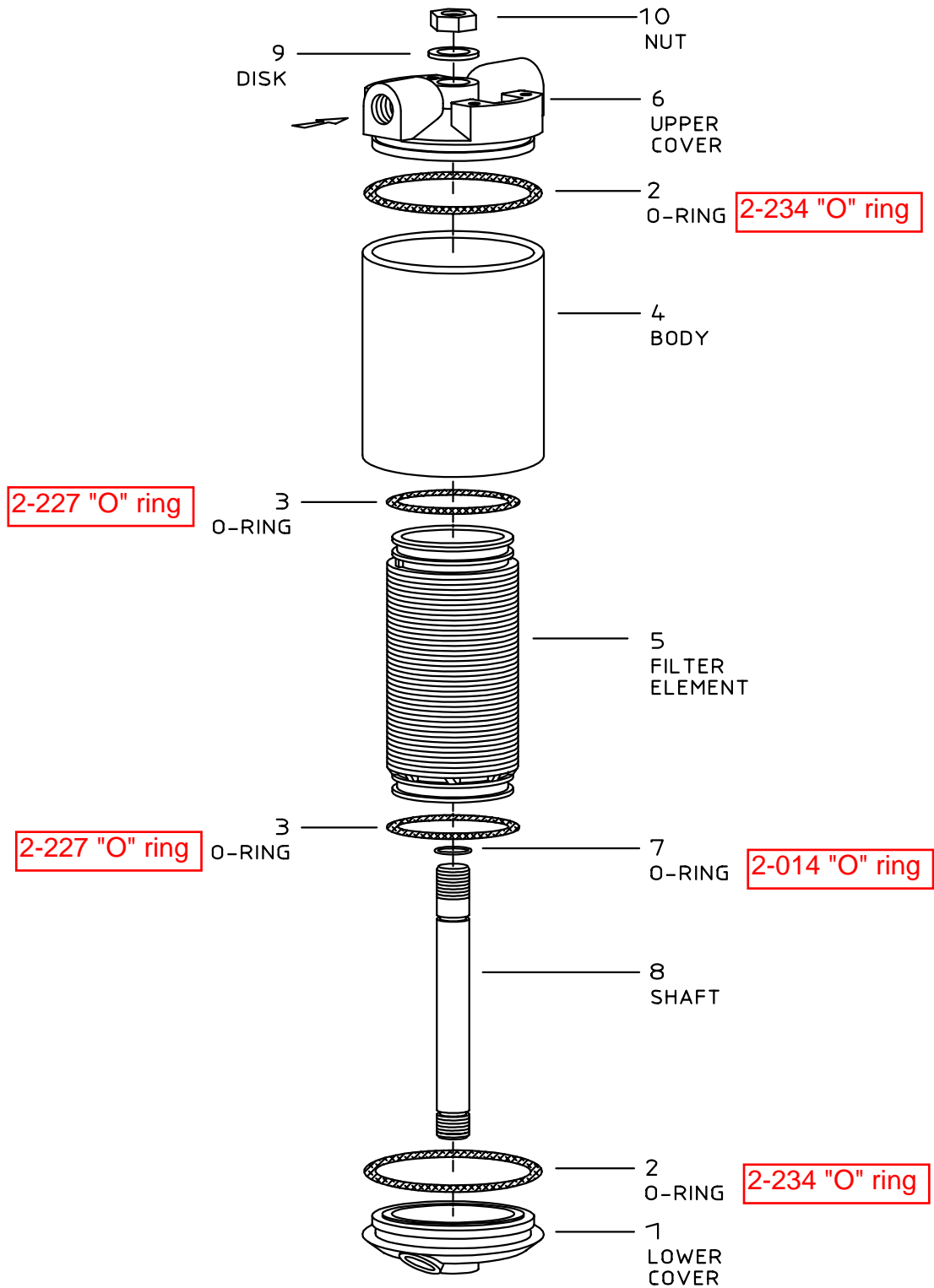

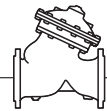

Diaphragm Actuated Basic Control Valves

Sizes: 4"-20"

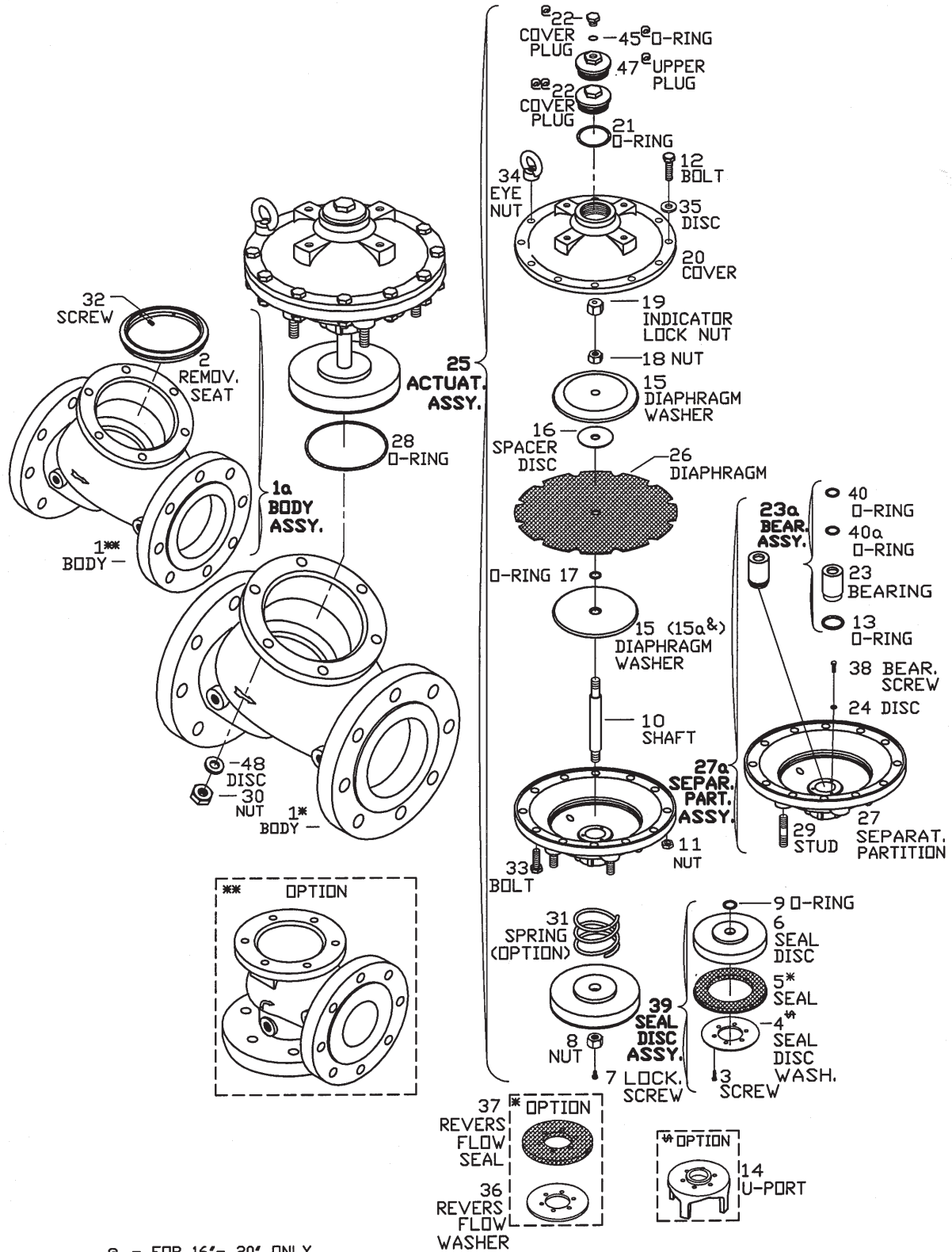

⊕ - FOR 16"- 20" ONLY
 ⊕⊕ - FOR 4"- 14" ONLY
 & - FOR HIGH PRESSURE ONLY

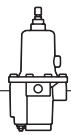

#X 3-way Positioning Hydraulic Pilot Valve

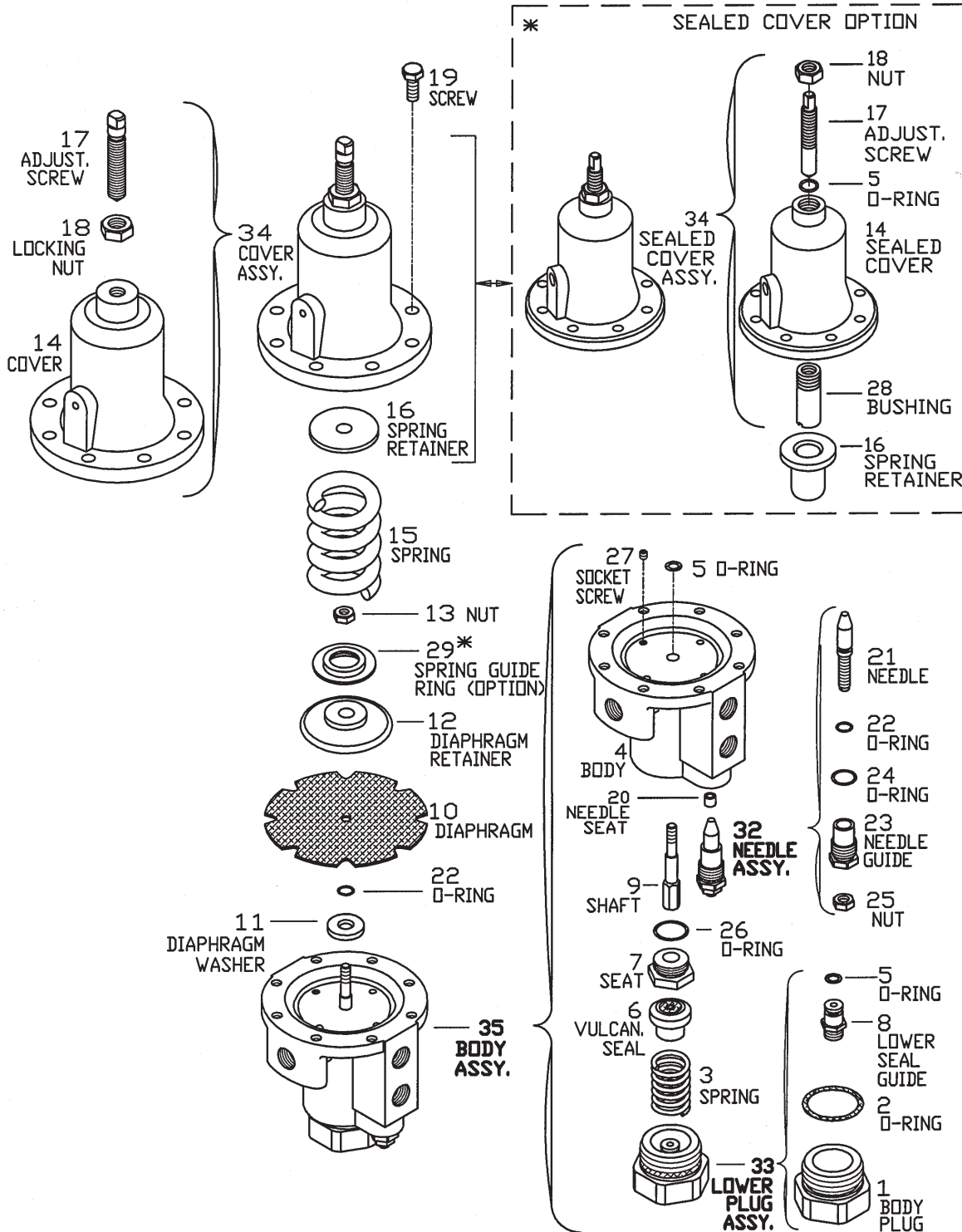

* - SEALED COVER OPTION

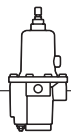

#8-16 3-way Altitude Pilot Valve (Maximum Setting 16 Meters)

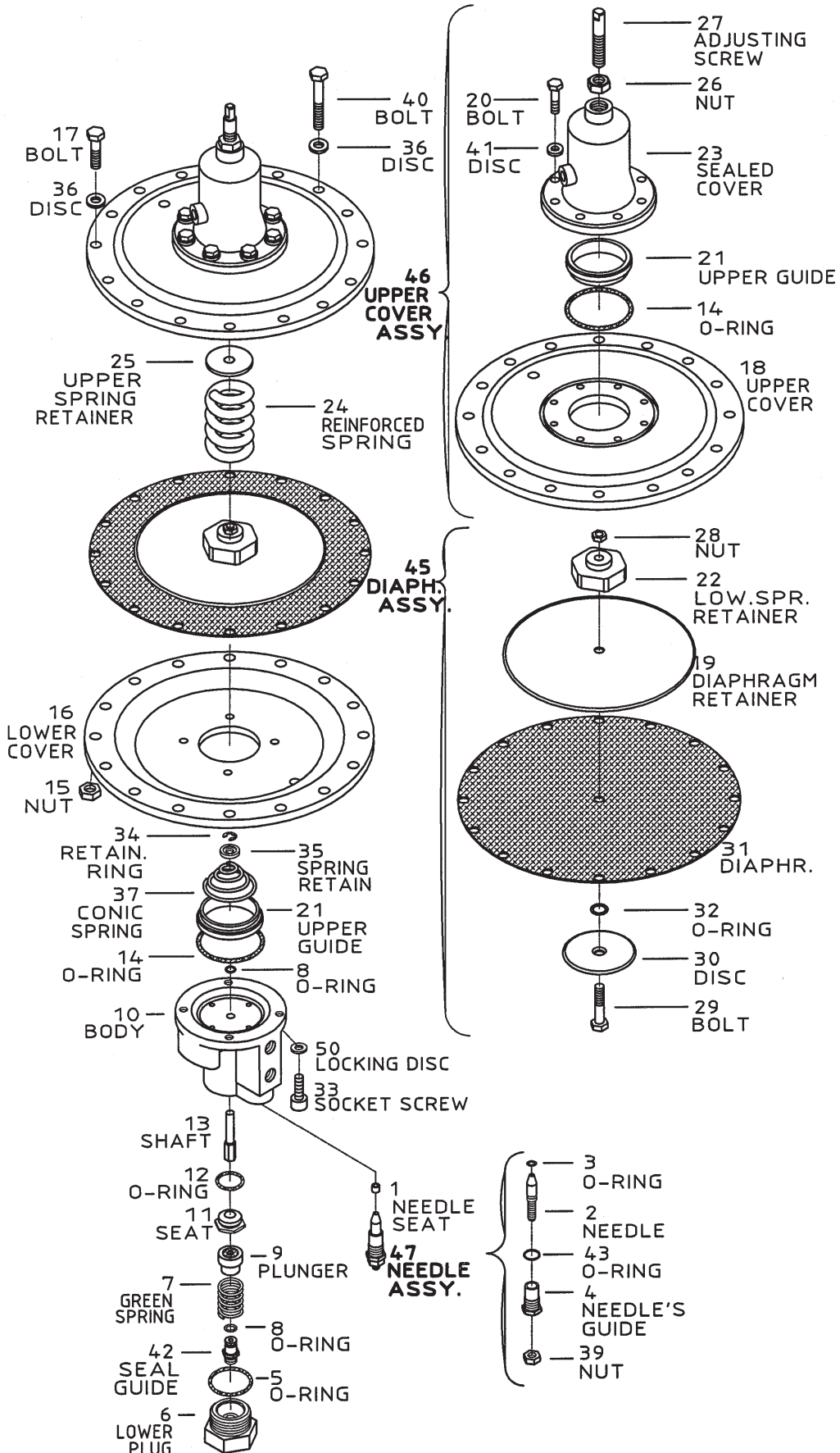



PC-Sharp-X Metal 3-Way Multi Purpose Mini Pilot Valve

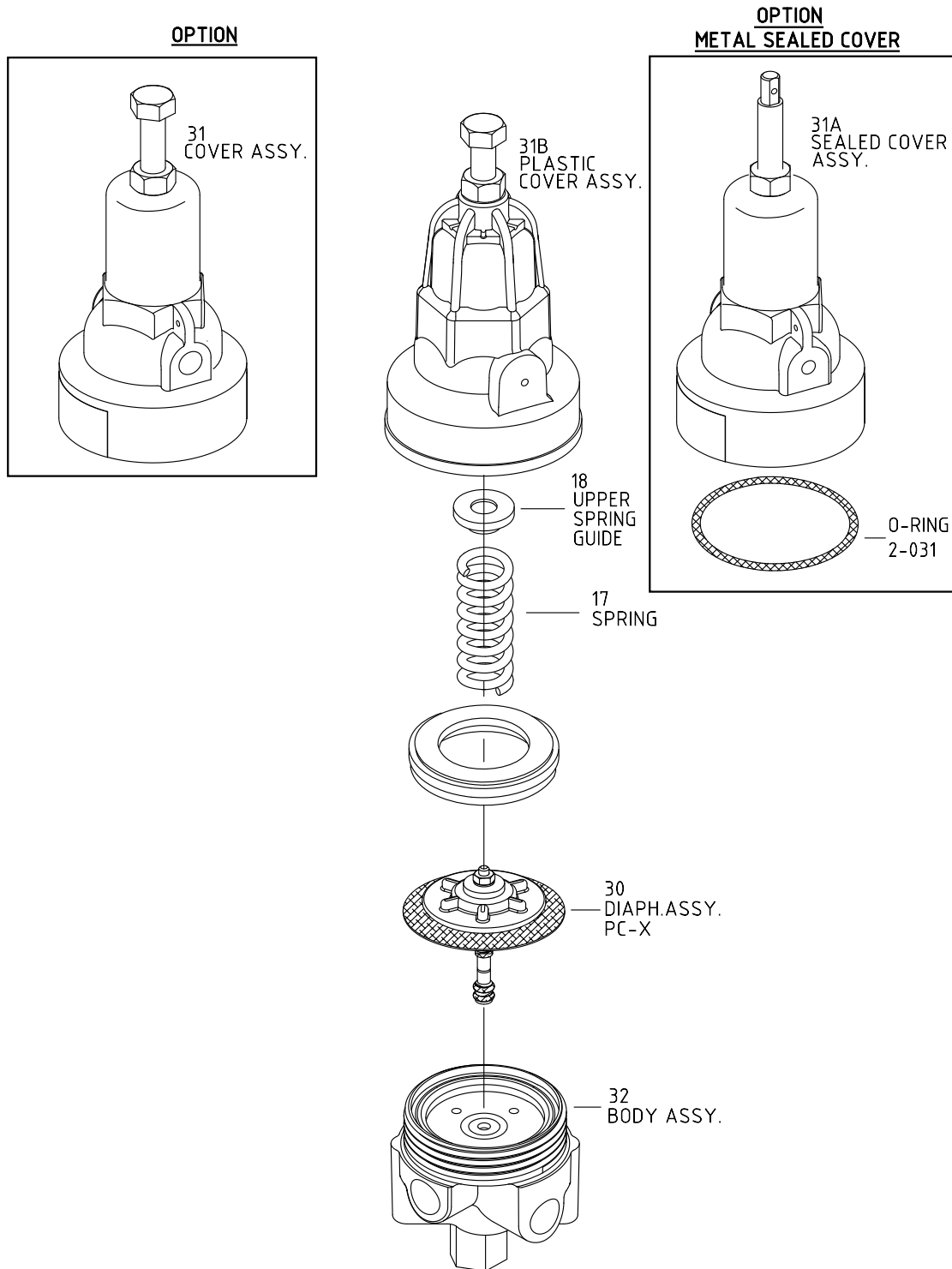

WW-700 Series Elastomers

Created 1.8.2009

Updated 5.8.09

Page Number	700	Part No.		Part No.		Part No.		Part No.		Part No.		Part No.		# KIT Item No.
		O-ring code # Item No. (Qty - 1)	O-ring code # Item No. (Qty - 2)	O-ring code # Item No. (Qty - 1)	O-ring code # Item No. (Qty - 2)	O-ring code # Item No. (Qty - 1)	O-ring code # Item No. (Qty - 2)	O-ring code # Item No. (Qty - 1)	O-ring code # Item No. (Qty - 2)	O-ring code # Item No. (Qty - 1)	O-ring code # Item No. (Qty - 2)	Material # Item No. (Qty - 1)	Material # Item No. (Qty - 1)	
38	1.5"-2.5" DN40-DN65	2-232	8	29	13	21	26	(p.41 p.43)	5	2520-00000				
		0535171232	0527172130	0517172007	0517172007	0526172310	25200B0510	0517172012	25200B2503					
39	3" DN80	2-237	9	13	35	21	26	(p.41 p.43)	5	2530-00000				
		0535171237	0527172130	0517172007	0517172007	0526172310	25300B0312	0517172012	25300B2506					
40	4" DN100	2-246	40	13	17	21	26	(p.41 p.43)	5	2540-00000				
		0535171246	0527172130	0526172466	0517172007	0526172310	22400B0026	0517172012	25400B2322					
40	6" DN150	2-364	9	13	17	21	26	(p.41 p.43)	5	2560-00000				
		0535171364	0535172061	0526172171	0527172130	0535172365	22600B0026	0517172012	25600B2305					
40	8" DN200	2-372	9	13	17	21	26	(p.41 p.43)	5	2580-00000				
		0535171372	053517216	0526172566	0526172111	0535172365	22801B0026	0517172012	25800B2305					
40	10" DN250	2-379	40	13	17	21	26	(p.41 p.43)	5	2510-00000				
		0535171379	0535172034	0526172160	0526172166	0535172365	22011B0026	0517172012	25010B2305					
40	12" DN300	2-456	9	13	17	21	26	(p.41 p.43)	5	2512-00000				
		0569171456	0553172027	0535172365	0526172466	0535172365	25120B0326	0517172012	25120B2305					
40	16"-20" DN400-500	2-466	2-230	2-340	2-223	2-119 + 2-236	NBR	2-011	NBR	2516-00000				
		0569171466	0535171230	0553171333	0535171223	0535172125 (21) & 0526172310 (45)	25160B0326	0517172012	25160B2305					

* Please note that some items may be used for various sizes and positions.
 * Data correct at "Updated" date only, please consult factory for updated data.