



COMBINATION AIR VALVE

Model C30

BERMAD C30 is a high quality combination air valve for a variety of water networks and operating conditions. It evacuates air during pipeline filling, allows efficient release of air pockets from pressurized pipes, and enables large volume air intake in the event of network draining.

With its advanced aerodynamic design, double orifice and Surge Protection device (optional), this valve provides excellent protection against air accumulation and prevents vacuum formation, with improved sealing in low pressure conditions.

Features & Benefits

- Straight flow body with large diameter automatic orifice: Higher than usual flow rates.
- Aerodynamic full-body kinetic shield: Prevents premature closing, without disturbing air intake or discharge.
- Dynamic sealing: Prevents leakage under low pressure conditions (1.5 psi; 0.1 bar).
- The boss on the base can be tapped with a thread for pressure gauge connection, check point or test drain for air valve function.
- Threaded Side outlet (2"; DN50) for connection of Surge Protection (code SP) or Inflow prevention (code IP) devices.
- Compact, simple and reliable structure with fully corrosion-resistant internal parts; lower maintenance and increased life span.
- Design in compliance with functional standard and water service standards.
- Factory approval and Quality Control: Performance and specification tested and measured with specialized test bench, including vacuum pressure conditions.

Additional Features & Accessories

- Surge Protection (code SP) device: Smoother operation, preventing damage to the valve and the system.
- Inflow Prevention (code IP) device: Prevents intake of atmospheric air in cases where this could lead to damaged pumps, required re-priming, or disruption of siphons.
- Service Ports fitted: 1/8";DN3 or 1/4";DN6 plug for pressure gauge connection, check point or test drain for air valve function.
- Extension with downwards outlet, only for inlet sizes 2-3"; DN50-80.



C30-P



C30-C

Typical Applications

- Pipelines: Protection against air accumulation and vacuum formation at elevations, slope change points and road/river crossings.
- Water networks: Protection against air accumulation and vacuum formation.
- In proximity to control valves and water meters: Prevention of inaccurate pressure regulation and biased readings due to air existence in these devices.

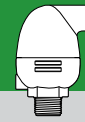

Inlet and Outlet Connections

- Inlets:
 - Plastic Body (C30-P): male threaded 3/4-2"; DN20-50, Flanged 2-3"; DN50-80
 - Ductile Iron Body (C30-C): male threaded 1-2"; DN25-50, Flanged 2"; DN50
- Plastic Body (C30-P):
 - Inlet connections 2-3"; DN50-80: Sideway Outlet, Female threaded 2"; DN50
 - Ductile Iron Body (C30-C):
 - Inlet connection 1"; DN25: Sideway Outlet, Female threaded 3/4"; DN20
 - Inlet connections 2"; DN50: Sideway Outlet, Female threaded 2"; DN50

Materials

- Body
 - Glass-reinforced Nylon (code C30-P)
 - Ductile Iron (code C30-C), coated with Fusion Bonded Epoxy, Blue
- Float Assembly: Polypropylene, Glass Reinforced Nylon.
- Elastomers: EPDM, Optional - Viton.

Operational Data

- Pressure Rating: 230 psi; ISO PN16
- Minimum operating pressure: 1.5 psi; 0.1 bar
- Maximum operating pressure: 230 psi; 16 bar
- Media and operating temperature: Water, 33-140°F; 1-60°C

Orifice Specifications

Inlet Sizes	Automatic Orifice	Kinetic Orifice		Surge Protection		
	Area	Diameter	Area	Number of holes	Hole Diameter	Total Area
Sq Inch	Sq inch	inch	Sq inch	—	inch	Sq inch
mm	Sq mm	mm	Sq mm		mm	Sq mm
3/4" - 1"	0.008	0.795	0.497	—	—	—
DN20 - 25	5.4	20.2	320	—	—	—
2" - 3"	0.019	1.772	2.465	4	0.157	0.078
DN50 - 80	12.2	45.0	1,590		4	50

Air Flow Performance Charts

Air Relief and Intake (Pipeline Filling, Draining and Vacuum Conditions)

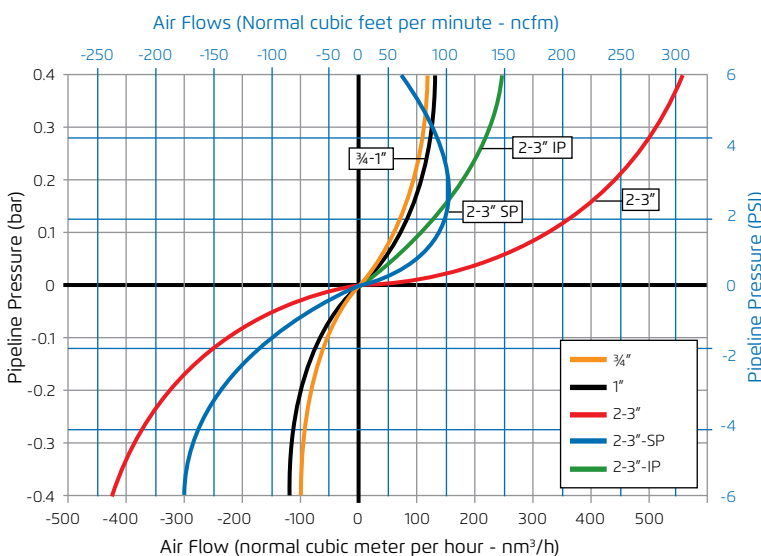

Air Release (Pressurized Operation)

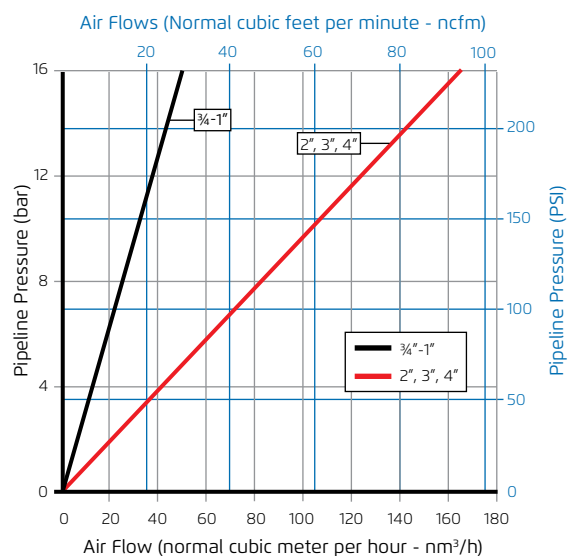

Air relief and intake charts are based on actual measurements, measured in Bermad Air Flow test bench, according to EN-1074/4 standard and refer to Side outlet. Use Bermad Air software for optimized Sizing & Positioning of Air Valves.



Model C30

Cutaway - Glass Reinforced Nylon Body (C30-P)

Female Threaded for retrofitting Surge Protection (Code SP) or Inflow Prevention (Code IP) devices or drain lines

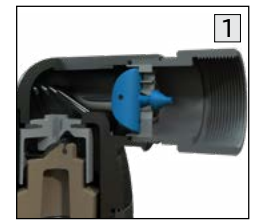
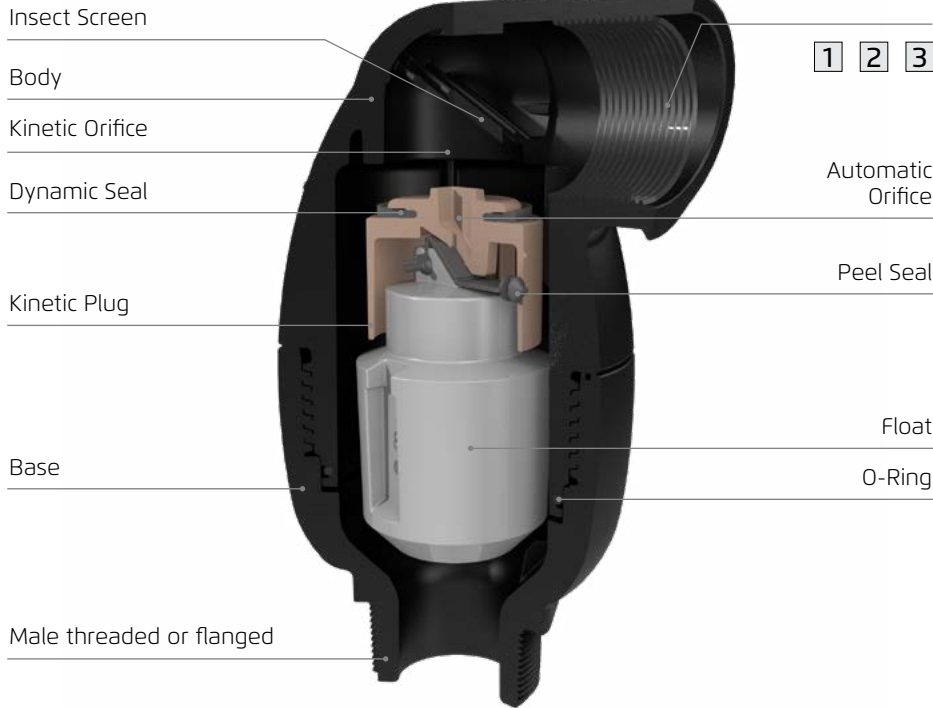

Surge Protection (code SP), only for inlet sizes 2-3"; DN50-80

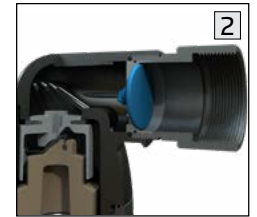

Inflow Prevention (code IP), only for inlet sizes 2-3"; DN50-80



Extension with downwards outlet, only for inlet sizes 2-3"; DN50-80

Cutaway - Ductile Iron Body (C30-C)

Female Threaded for retrofitting Surge Protection (Code SP) or Inflow Prevention (Code IP) features or drain lines

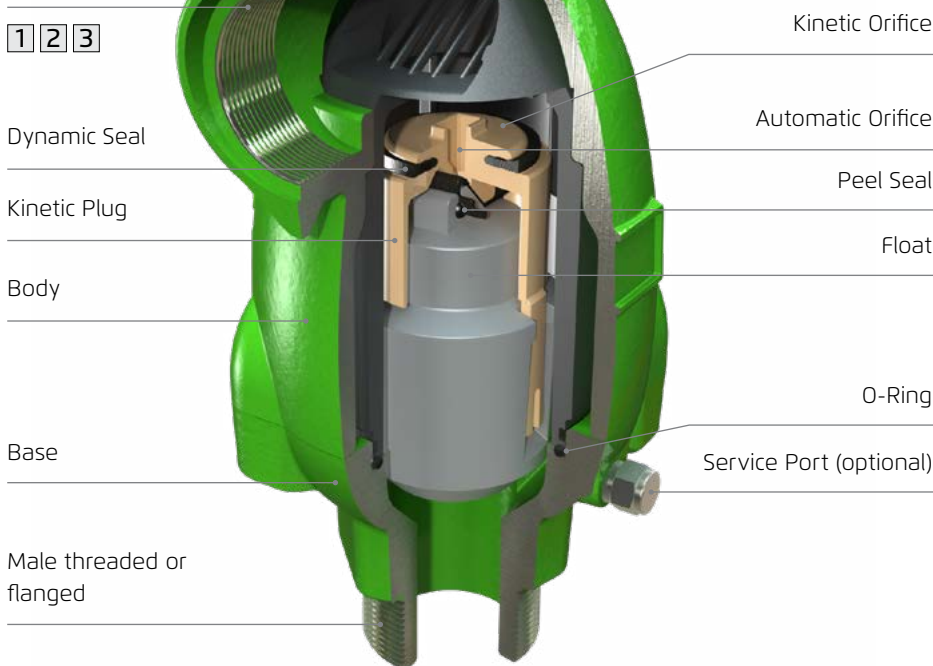

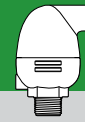

Dimensions & Weights

Inlet Size	Connection	C30-P			C30-C		
		Width (D)	Height (H)	Weight	Width (D)	Height (H)	Weight
inch	---	inch	inch	lbs	inch	inch	lbs
mm	---	mm	mm	Kg	mm	mm	Kg
3/4"	Threaded	3.819	6.299	0.99	--	--	--
DN20		97	160	0.45	--	--	--
1"	Threaded	3.819	6.299	0.99	7.087	4.331	4.85
DN25		97	160	0.45	180	110	2.2
2"	Threaded	5.630	9.055	2.87	6.181	9.764	13.66
DN50		143	230	1.3	157	248	6.2
2"	Flanged	6.496	9.449	4.30	7.480	9.843	22.70
DN50		165	240	1.95	190	250	10.3
3"	Flanged	7.874	9.449	4.96	--	--	--
DN80		200	240	2.25	--	--	--

