

# Engineering

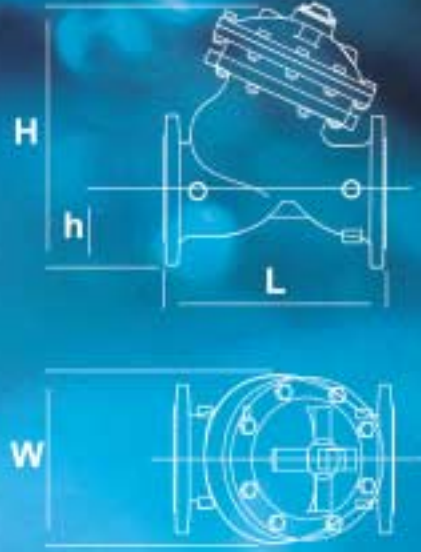
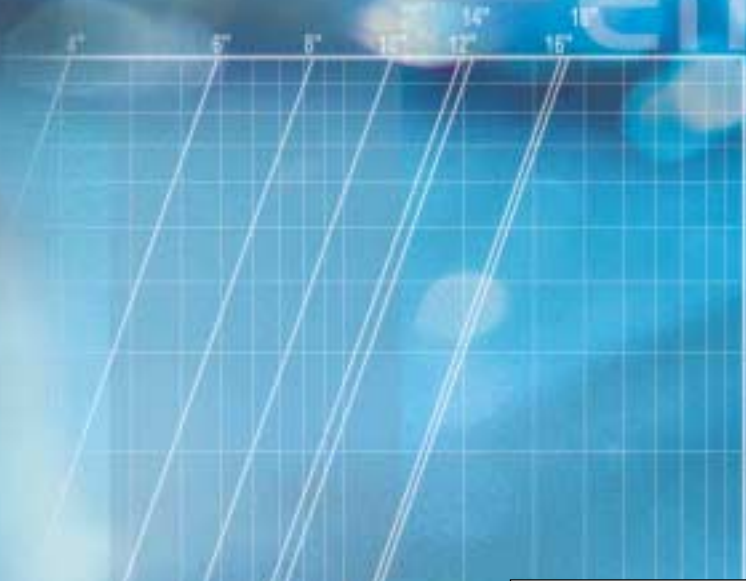

**BERMAD**

**700 Series**

## Hydraulic Control Valves Engineering Data



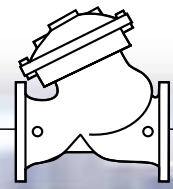

# Contents

## 700 Series - Engineering Data

■ Introduction	Page 2
■ Product Features	Pages 3-4
■ Valve - Exploded view	Page 5
■ Principles of Operation	Page 6
■ Technical Specifications	Page 7
■ Pressure Rating	Page 8
■ Dimensions and Weights, SI (Metric units)	Page 9
■ Dimensions and Weights, US (English units)	Page 10
■ Flow Chart "Y" and Angle pattern, Flat Disc - SI	Page 11
■ Flow Chart "Y" and Angle pattern, Throttling Plug (U-Type) - SI	Page 12
■ Flow Chart "Y" and Angle pattern, Flat Disc - US	Page 13
■ Flow Chart "Y" and Angle pattern, Throttling Plug (U-Type) - US	Page 14
■ Cavitation	Page 15
■ Practical Hydraulic Data	Page 16
■ Valve Plugs Characteristics	Page 17
■ Typical Pressure Reducing Performance Chart	Page 17



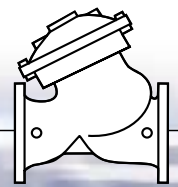

## Introduction

### BERMAD 700 SERIES HYDRAULIC CONTROL VALVES

#### Overview

The 700 Series is the BERMAD flagship product line, especially for Waterworks applications.

This Engineering Guide will assist in the selection of the most appropriate BERMAD valves by presenting and organizing the necessary technical data into easy-to-read formats.

#### Basic Design Features

The basic body design (globe or angle) results in lower pressure loss, reduced weight, and higher resistance to cavitation damage compared to that of a conventional globe control valve.

Valves are available in sizes 1½ to 32 inch (40-800 mm), threaded or flanged, with pressure ratings up to ISO PN 25; ANSI Class 300 psi. The valves are hydraulically operated by means of diaphragm actuators, (except for high-pressure application piston actuators). Principally, the valves are constructed of ductile iron, cast iron or steel (other alloys are available) and are available with various protective coatings.

The double-chambered actuator provides a versatility not found in conventional control valves and achieves smooth drip-tight closing, accurate regulation and positive on/off control. The associated control trim provides all the necessary coordinated and complementary accessories for optimum valve operation. This actuator resists wear and tear from movement, prevents leakage due to dirt, is not sensitive to sediments, and has no need for lubrication. The life expectancy of its Nylon-reinforced diaphragm is virtually endless.

The standard flat sealing disk assembly includes a seal of NBR (Buna-N). Many special sealing materials are also available. The flat disc can be replaced by a throttling plug for applications with low flows and high pressure drops.

Optionally, the valve can be fitted with several accessories such as a valve position indicator, a mechanical closure and flow adjuster (for manual operation), limit switch assemblies (for position remote monitoring), and a lift spring assembly.

#### Standards

BERMAD is certified according to the ISO 9001 Quality Assurance Standard and each valve is certified as complying with NSF, WRAS, and other recognized international standards.

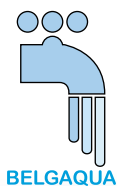

BERMAD 700 Series Catalog

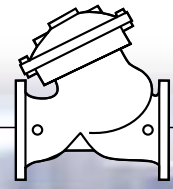

[ 1 ] - **Double Chambered Actuator**

The entire actuator assembly (seal disk to top cover) can be easily removed from the valve body as one complete unit, providing ease of inspection and maintenance.

[ 2 ] - **Cover Plug**

Enables on-site retrofit of:

**Indicator:** For visual valve opening indication

**Limit-switch:** For signaling valve position to control system

**Valve Position Transmitter:** For analog transmission of valve position to control system

[ 3 ] - **Diaphragm Assembly**

The unshaped, nylon reinforced, diaphragm is supported by the cover and separation partition on its circumference while the diaphragm washers provide full support over the majority of the surface. It is centrally guided. Diaphragm load is limited to only stretching forces applied to the active area.

[ 4 ] - **Inherent Separation Partition**

The built-in separation partition includes the bearing which provides complete central guiding for the valve moving assembly. In the double chambered configuration, it isolates the lower control chamber from the flow. In the single chambered configuration, it separates the lower control chamber from the flow so that the diaphragm is protected and free from flow stresses.

[ 5 ] - **Spring**

Optional for single-chambered configurations or when the check feature is required.

Superfluous for double-chambered configurations.

[ 6 ] - **Seal Disc Assembly**

Self-aligning, seal disc assembly provides balanced, free movement and a resilient seal for perfect, drip-tight sealing. It enables using several variations of seals and plugs for a wide range of applications and working conditions.

[ 7 ] - **Seat**

Stainless steel, raised, replaceable in-line and on-site.

[ 8 ] - **Wide Body ("Y" or Angle pattern)**

Hydrodynamically designed for efficient flow with minimal pressure loss and excellent resistance to cavitation.

Full bore, valve port area clear of obstructions, no ribs or stem guides.

Increases capacity by 25% over ordinary globe valves. Also Angle pattern valve is available.

[ 9 ] - **End Connections**

Conforms to pressure ratings and standards of: ISO, ANSI, JIS, BS, and others.

### Valve Plug Options

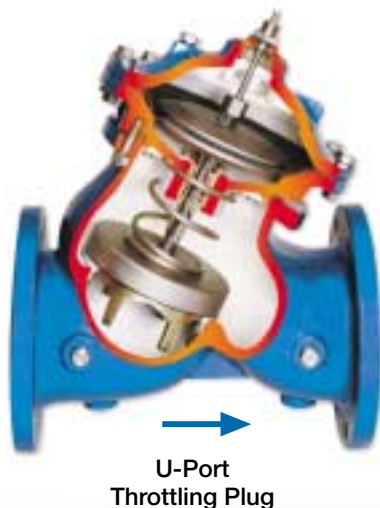

**Flat disc:**

"Quick opening plug": Standard plug provides high flow and quick response.

**Throttling plugs:**

A throttling plug is used in order to provide more accurate, stable and smooth response for pressure and flow regulation while reducing noise and vibration. Two types are available:

"U" contour (standard) and "V" contour.

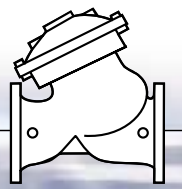

[1]

[2]

[3]

[4]

[5]

[6]

[7]

[8]

[9]

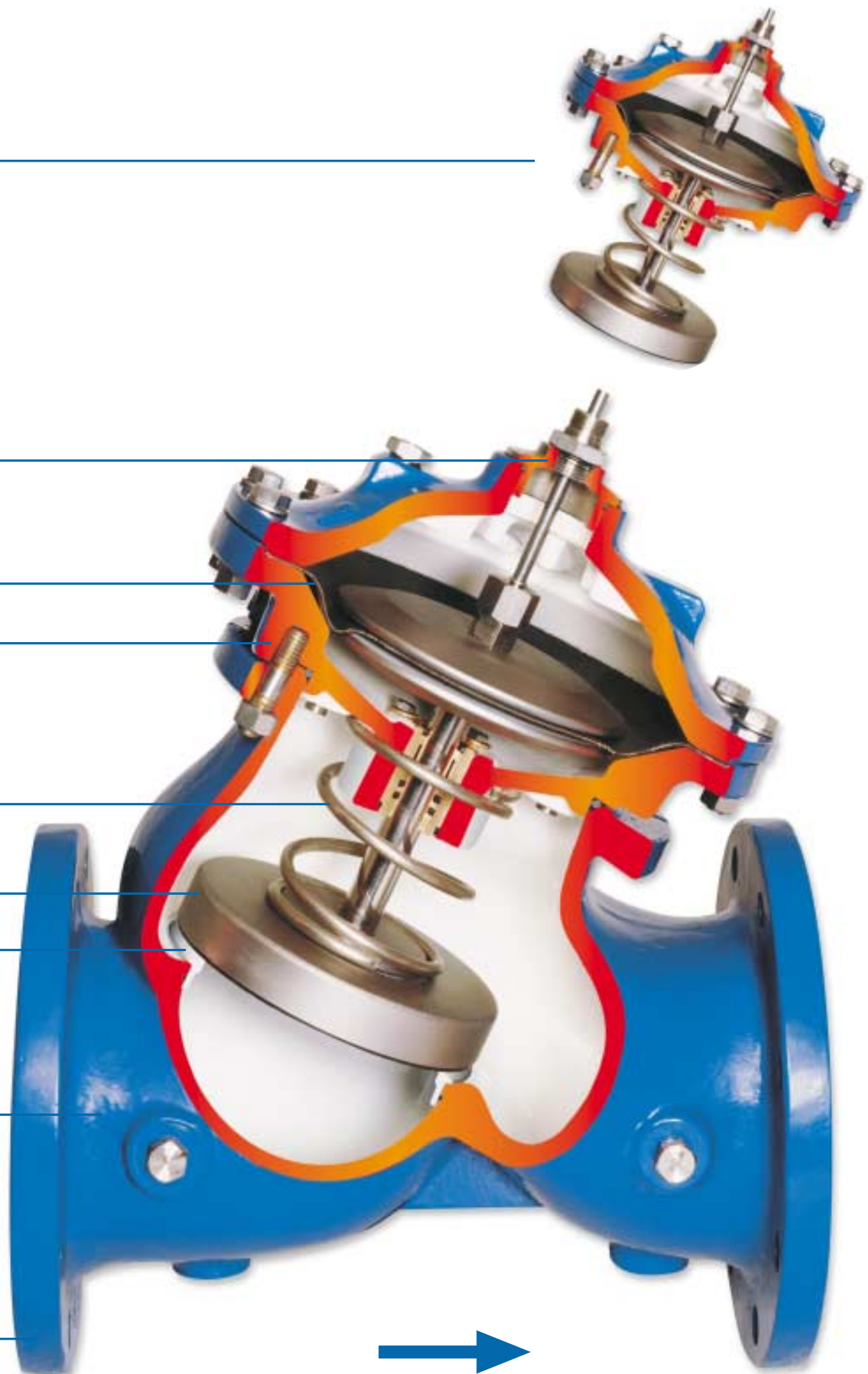

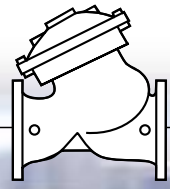

## Valve - Exploded View

700 Series

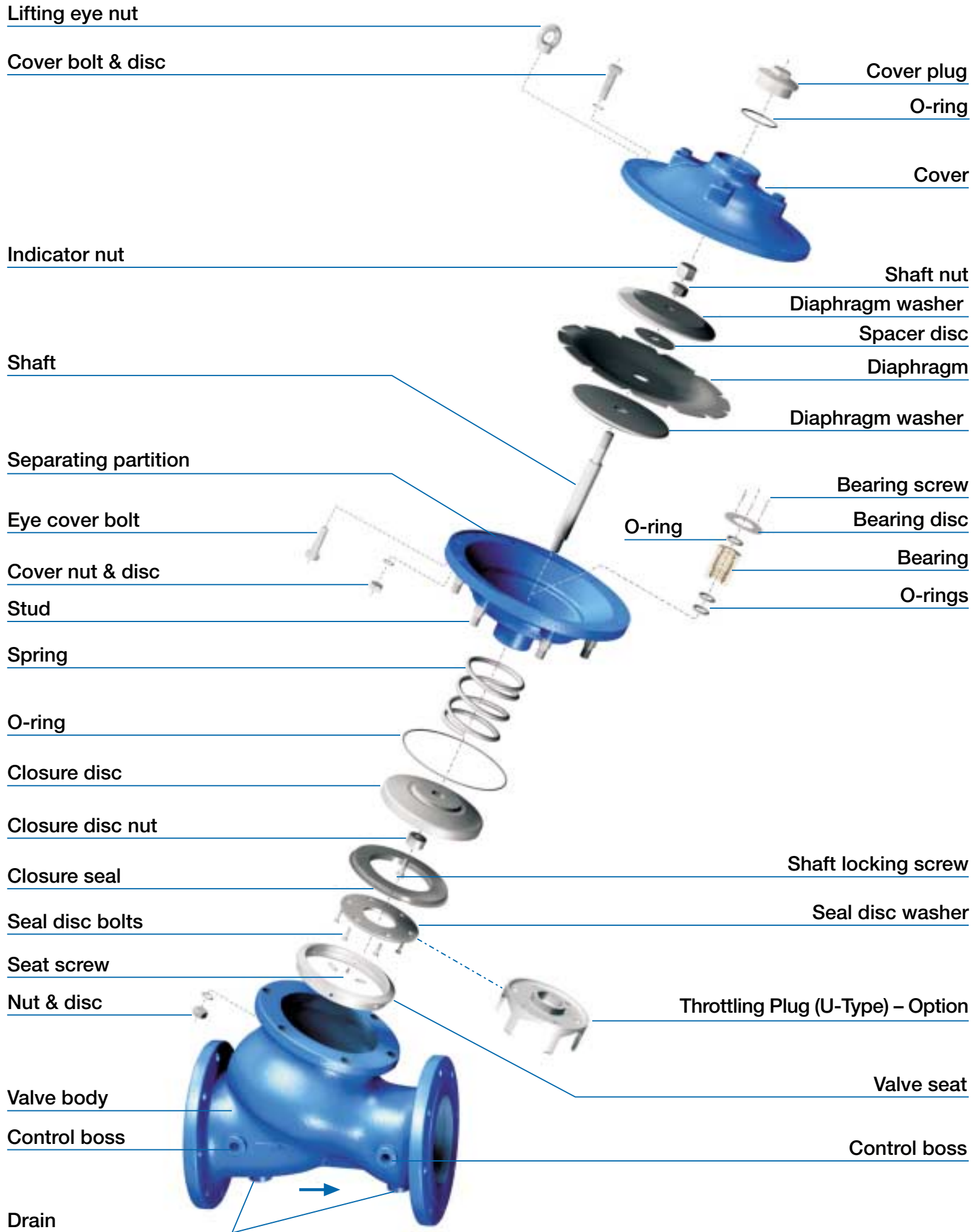

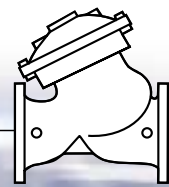

### On-Off Modes

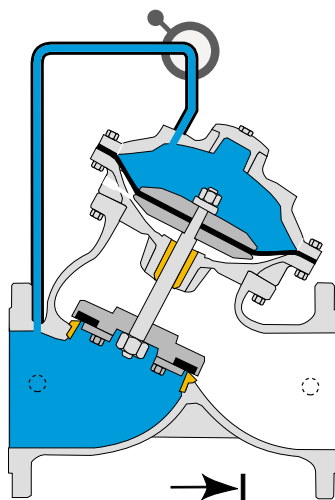

#### Closed Position

Line pressure applied to the upper control chamber of the valve creates a superior force that moves the valve to the closed position and provides drip tight sealing.

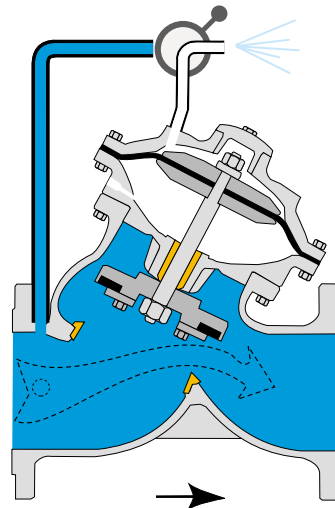

#### Open Position

Discharging the pressure in the upper control chamber to atmosphere or some other lower pressure zone causes the line pressure acting on the seal disc to move the valve to the open position.

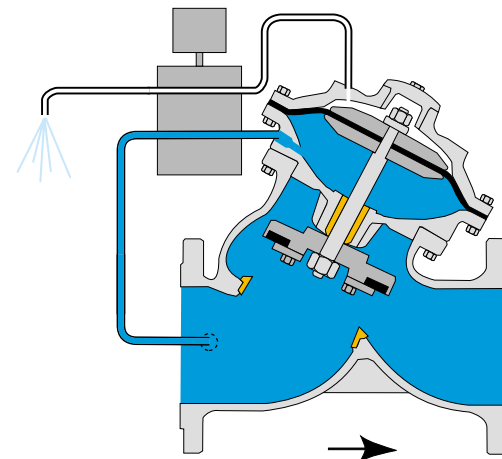

#### Powered Open Position

Pressure in the upper control chamber is discharged and line pressure is applied to both the lower control chamber and the seal disc. This creates a force that powers the valve to the open position.

### Modulating Mode

#### Pressure Reducing Models

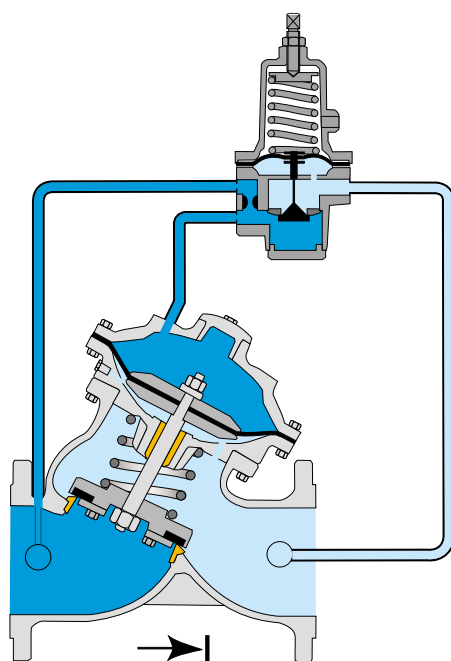

#### Closed Position

The closed adjustable pilot valve traps line pressure in the upper control chamber and the resulting force moves the valve to the fully closed position.

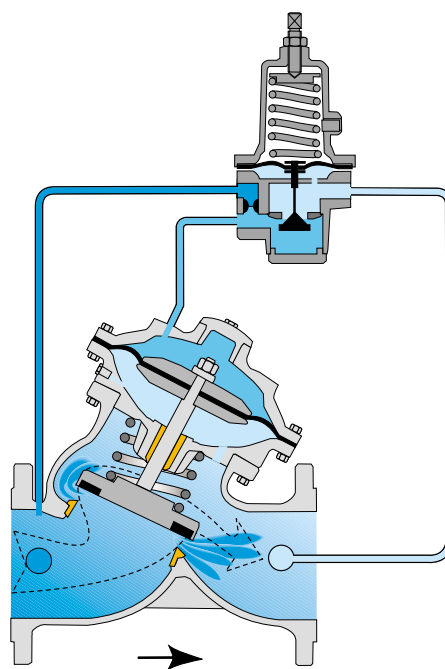

#### Modulating Position

The pilot valve senses and reacts to line pressure changes and opens or closes accordingly. The pilot valve controls the pressure in the upper control chamber of the valve causing the valve to modulate to an intermediate position between fully open and closed.

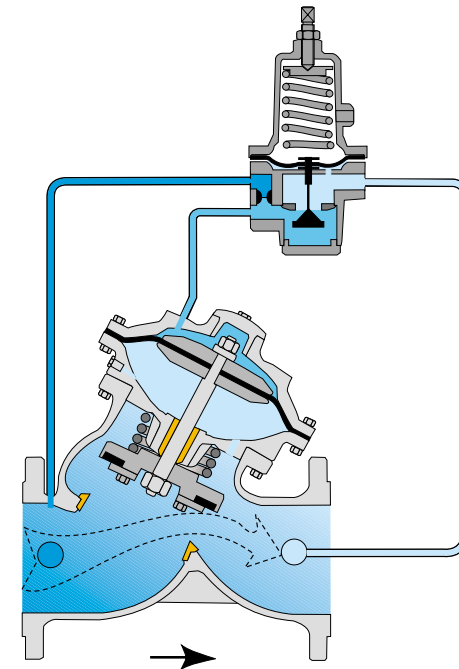

#### Modulating Open Position

The open pilot valve releases line pressure from the upper control chamber and the line pressure acting on the seal disc moves the valve to the open position.

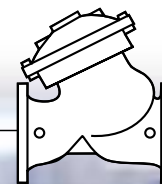

#### SI Metric

##### Connection Standard

- Flanged: ISO 700S-1 (Ductile iron),
- Threaded: NPT or BSP 40, 50, 65 & 80 mm

##### Water Temperature

- Up to 80°C

##### Available Sizes ("Y" & Angle)

- 40, 50, 65, 80, 100, 150, 200, 250, 300, 350, 400, 450, 500, 600, 700, 750 and 800 mm

##### Working pressure

- ISO PN 16: 16 bar
- ISO PN 25: 25 bar

##### Standard Materials

- **Main valve body and cover**  
Ductile iron EN 1563
- **Main valve internals**  
Stainless steel, bronze and coated steel
- **Control Trim**  
Brass Components/Accessories  
Forged brass fittings & copper tubing
- **Elastomers**  
NBR (Buna-N)  
EPDM  
Viton
- **Coating**  
Fusion Bonded Epoxy, RAL 5005 (Blue)  
NSF 61 and WRAS approved  
or Electrostatic Polyester Powder, RAL 6017 (Green)

##### Optional Materials

- **Main valve body/internals**  
Cast Carbon steel ASTM A-216-WCB  
Cast Stainless steel 316 CF8M (316)  
Aluminum  
Ni.Al. bronze  
Titanium  
Alloy 20  
Duplex  
Hastalloy  
Marine Bronze  
SMO
- **Control Trim**  
Stainless steel 316  
Hastalloy C-276

#### US English

##### Connection Standard

- Flanged: ANSI B16.42 (Ductile iron),
- Threaded: NPT or BSP 1 1/2, 2, 2 1/2 & 3 inch

##### Water Temperature

- Up to 180°F

##### Available Sizes ("Y" & Angle)

- 1 1/2, 2, 2 1/2, 3, 4, 6, 8, 10, 12, 14, 16, 18, 20, 24, 28, 30 and 32 inch

##### Working pressure

- Class #150: 250 psi
- Class #300: 400 psi

##### Manufacturers Standard Materials

- **Main valve body and cover**  
Ductile iron ASTM A-536
- **Main valve internals**  
Stainless steel, bronze and coated steel
- **Control Trim**  
Brass Components/Accessories  
Forged brass fittings & copper tubing
- **Elastomers**  
NBR (Buna-N)  
EPDM  
Viton
- **Coating**  
Fusion Bonded Epoxy, RAL 5005 (Blue)  
NSF 61 and WRAS approved  
or Electrostatic Polyester Powder, RAL 6017 (Green)

##### Optional Materials

- **Main valve body/internals**  
Cast Carbon steel ASTM A-216-WCB  
Cast Stainless steel CF8M (316)  
Aluminum  
Ni.Al. bronze  
Titanium  
Alloy 20  
Duplex  
Hastalloy  
Marine Bronze  
SMO
- **Control Trim**  
Stainless steel 316  
Hastalloy C-276



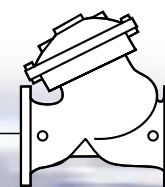

### Pressure Rating

### 700 Series

#### Standard Operation Pressure – Materials Data

End Connections Standards / Pressure Ratings / Materials / Max. Operating Pressure

Bermad Code	End Connections Standard	Pressure Class	Cast Iron ASTM A-126 B	Bronze ASTM B 62	Ductile Iron ASTM A-536	Carbon Steel ASTM A-216 WCB	Stainless Steel ASTM A-531 CF 8M
10	ISO	PN 10	10 bar	+	+	+	+
16	ISO	PN 16	16 bar	16 bar	+	+	+
25	ISO	PN 25	-	25 bar	25 bar	25 bar	25 bar
A1	ANSI	# 125	175 psi	+	+	+	+
A2	ANSI	# 250	300 psi	+	+	+	+
A5	ANSI	# 150	-	225 psi	250 psi	285 psi	285 psi
A3	ANSI	# 300	-	400 psi	400 psi	400 psi	400 psi
BD	BS 10	Table D	100 psi	+	+	+	+
BS	BS 10	Table H	300 psi	400 psi	400 psi	400 psi	400 psi
J1	JIS	10 K	14 bar	+	+	+	+
J6	JIS	16 K	22 bar	27 bar	27 bar	27 bar	27 bar
J2	JIS	25 K	-	28 bar	28 bar	28 bar	28 bar
B1	ABNT	10	10 bar	+	+	+	+
B6	ABNT	16	16 bar	16 bar	+	+	+
B2	ABNT	25	-	25 bar	25 bar	25 bar	25 bar
	Threads						
BP	BSP		16 bar				
PH	BSP			25 bar	25 bar	25 bar	25 bar
NP	NPT		230 psi				
NH	NPT			400 psi	400 psi	400 psi	400 psi

+ Available, Not required by the standard pressure class  
 - Not available

#### Control Chamber Displacement Volume

Sizes	mm	40	50	60	80	100	150	200	250	300	350	400	450	500	600-800
	inch	1 1/2"	2"	2 1/2"	3"	4"	6"	8"	10"	12"	14"	16"	18"	20"	24"-32"
Volume	Liter	0.125	0.125	0.125	0.3	0.45	2.15	4.5	8.5	12.4	12.4	29.8	29.8	29.9	98
	Gallon	0.03	0.03	0.03	0.03	0.12	0.57	1.19	2.25	3.28	3.28	7.88	7.88	7.88	25.9

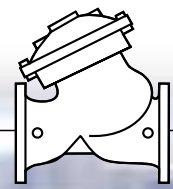

### Dimensions & Weights

### 700 Series

**SI** Metric

#### Flanged

##### Y Pattern

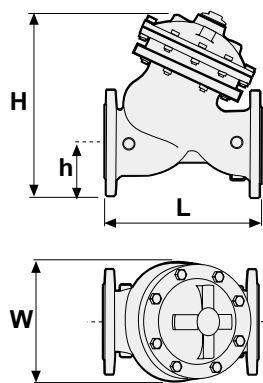

	mm	40	50	65	80	100	150	200	250	300	350	400	450	500
ISO PN 10; 16	L	205	210	222	250	320	415	500	605	725	733	990	1000	1100
	W	155	165	178	200	223	320	390	480	550	550	740	740	740
	h	78	83	95	100	115	143	172	204	242	268	300	319	358
	H	239	244	257	305	366	492	584	724	840	866	1108	1127	1167
	Weight (Kg)	9.1	10.6	13	22	37	75	125	217	370	381	846	945	962
ISO PN 20; 25	L	205	210	222	264	335	433	524	637	762	767	1024	1030	1136
	W	155	165	185	207	250	320	390	480	550	570	740	740	750
	h	78	83	95	105	127	159	191	223	261	295	325	357	389
	H	239	244	257	314	378	508	602	742	859	893	1133	1165	1197
	Weight (Kg)	10	12.2	15	25	43	85	146	245	410	434	900	967	986

##### G Pattern

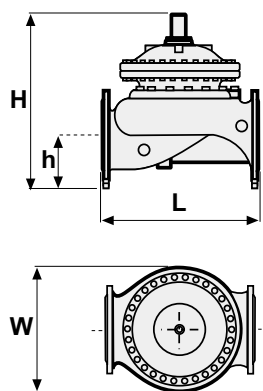

	mm	600	700	750	800
ISO PN 10; 16	L	1450	1650	1750	1850
	W	1250	1250	1250	1250
	h	470	490	520	553
	H	1965	1985	2015	2048
	Weight (Kg)	3250	3700	3900	4100
ISO PN 20; 25	L	1500	1650	1750	1850
	W	1250	1250	1250	1250
	h	470	490	520	553
	H	1965	1985	2015	2048
	Weight (Kg)	3500	3700	3900	4100

##### Angle Pattern

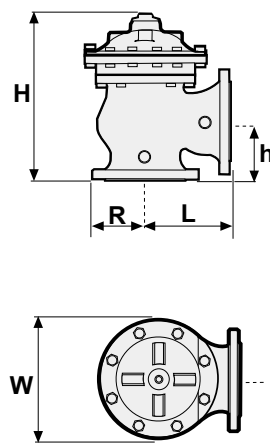

	mm	40	50	65	80	100	150	200	250	300	350	400	450
ISO PN 10; 16	L	124	124	149	152	190	225	265	320	396	400	450	450
	W	155	155	178	200	222	320	390	480	550	550	740	740
	R	78	83	95	100	115	143	172	204	248	264	299	320
	h	85	85	109	102	127	152	203	219	273	279	369	370
	H	227	227	251	281	342	441	545	633	777	781	1082	1082
	Weight (Kg)	9.5	10	20	21.5	35	71	118	205	350	370	800	820
ISO PN 20; 25	L	124	124	149	159	200	234	277	336	415	419	467	467
	W	165	165	185	207	250	320	390	480	550	550	740	740
	R	78	85	95	105	127	159	191	223	261	293	325	358
	h	85	85	109	109	135	165	216	236	294	299	386	386
	H	227	227	251	287	350	454	558	649	796	801	1099	1099
	Weight (Kg)	11	11.5	13.5	23	41	81	138	233	390	245	855	870

#### Threaded

##### Y Pattern

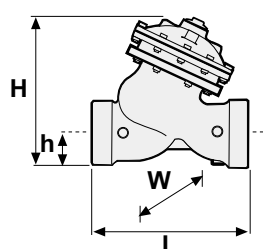

	mm	40	50	65	80
BSP; NPT	L	155	155	212	250
	W	122	122	122	163
	h	40	40	48	56
	H	201	202	209	264
	Weight (Kg)	5.5	5.5	8	17

##### Angle Pattern

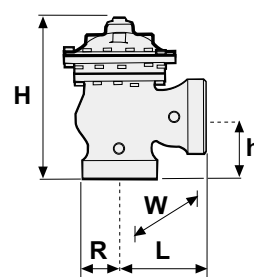

	mm	50	65	80
BSP; NPT	L	121	140	159
	W	122	122	163
	R	40	48	55
	h	83	102	115
	Weight (Kg)	5.5	7	15

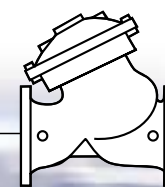

## Dimensions & Weights

**US** English

### Flanged

#### Y Pattern

		inch	1½"	2"	2½"	3"	4"	6"	8"	10"	12"	14"	16"	18"	20"
	ANSI 125 ; 150	L	8.1	8.1	8.3	9.8	12.6	16.3	19.7	23.8	28.5	28.9	39.0	39.4	43.3
		W	6.1	6.1	7.0	7.9	8.8	12.6	15.4	18.9	21.7	21.7	29.1	29.1	29.1
		h	3.1	3.3	3.7	3.9	4.5	5.6	6.8	8.0	9.5	10.6	11.8	12.6	14.1
		H	9.4	9.6	10.1	12.0	14.4	19.4	23.0	28.5	33.1	34.1	43.6	44.4	45.9
	ANSI 250 ; 300	L	8.1	8.3	8.7	10.4	13.2	17.0	20.6	25.1	30.0	30.2	40.3	227.1	44.7
		W	6.1	6.5	7.3	8.1	9.8	12.6	15.4	18.9	21.7	22.4	29.1	29.1	29.5
		h	3.1	3.3	3.7	4.1	5.0	6.3	7.5	8.8	10.3	11.6	12.8	14.1	15.3
		H	9.4	9.6	10.1	12.4	14.9	20.0	23.7	29.2	33.8	35.2	44.6	45.9	47.1
		Weight (lb)	20	23	29	49	82	165	276	478	816	840	1865	2083	2121
		Weight (lb)	22	27	33	55	95	187	322	540	904	957	1984	2132	2174

#### G Pattern

		inch	24"	28"	30"	32"
	ANSI 125 ; 150	L	57	65	70	73
		W	49	49	49	49
		h	18.5	19	20.5	21.8
		H	77	78	79.3	80.6
	ANSI 250 ; 300	L	59	65	70	73
		W	49	49	49	49
		h	18.5	19	20.5	21.8
		H	77	78	79.3	80.6
		Weight (lb)	7150	8140	8580	9020
		Weight (lb)	7700	8140	8580	9020

#### Angle Pattern

		inch	1½"	2"	2½"	3"	4"	6"	8"	10"	12"	14"	16"	18"
	ANSI 125 ; 150	L	4.9	4.9	5.9	6.0	7.5	8.9	10.4	12.6	15.6	15.7	17.7	17.7
		W	6.1	6.1	7.0	7.9	8.7	12.6	15.4	18.9	21.7	21.7	29.1	29.1
		R	3.1	3.3	3.7	3.9	4.5	5.6	6.8	8.0	9.8	10.4	11.8	12.6
		h	3.3	3.3	4.3	4.0	5.0	6.0	8.0	8.6	10.7	11.0	14.5	14.5
		H	8.9	8.9	9.9	11.1	13.5	17.4	21.5	24.9	30.6	30.7	42.6	42.6
		Weight (lb)	21	22	44	47	77	157	260	452	772	816	1764	1808
	ANSI 250 ; 300	L	4.9	4.9	5.9	6.3	7.9	9.2	10.9	13.2	16.3	16.5	18.4	18.4
		W	6.5	6.5	7.3	8.1	9.8	12.6	15.4	18.9	21.7	21.7	29.1	29.1
		R	3.1	3.3	3.7	4.1	5.0	6.3	7.5	8.8	10.3	11.5	12.8	14
		h	3.3	3.3	4.3	4.3	5.3	6.5	8.5	9.3	11.6	11.8	15.2	15.2
		H	8.9	8.9	9.9	11.3	13.8	17.9	22.0	25.6	31.3	31.5	43.3	43.3
		Weight (lb)	24	25	30	51	90	179	304	514	860	540	1885	1918

### Threaded

#### Y Pattern

		inch	1½"	2"	2½"	3"
	BSP ; NPT	L	6.1	6.1	8.3	9.8
		W	4.8	4.8	4.8	6.4
		h	1.6	1.6	8.2	2.2
		H	7.9	8.0	8.2	10.4
		Weight (lb)	12	12	18	37

#### Angle Pattern

		inch	2"	2½"	3"
	BSP ; NPT	L	4.8	5.5	6.3
		W	4.8	4.8	6.4
		R	1.6	1.9	2.2
		h	3.3	4.0	4.5
		H	8.9	9.5	11.6
		Weight (lb)	12	15	33



**SI** Metric

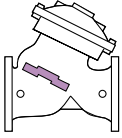

## Y Pattern, Flat Disc

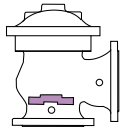
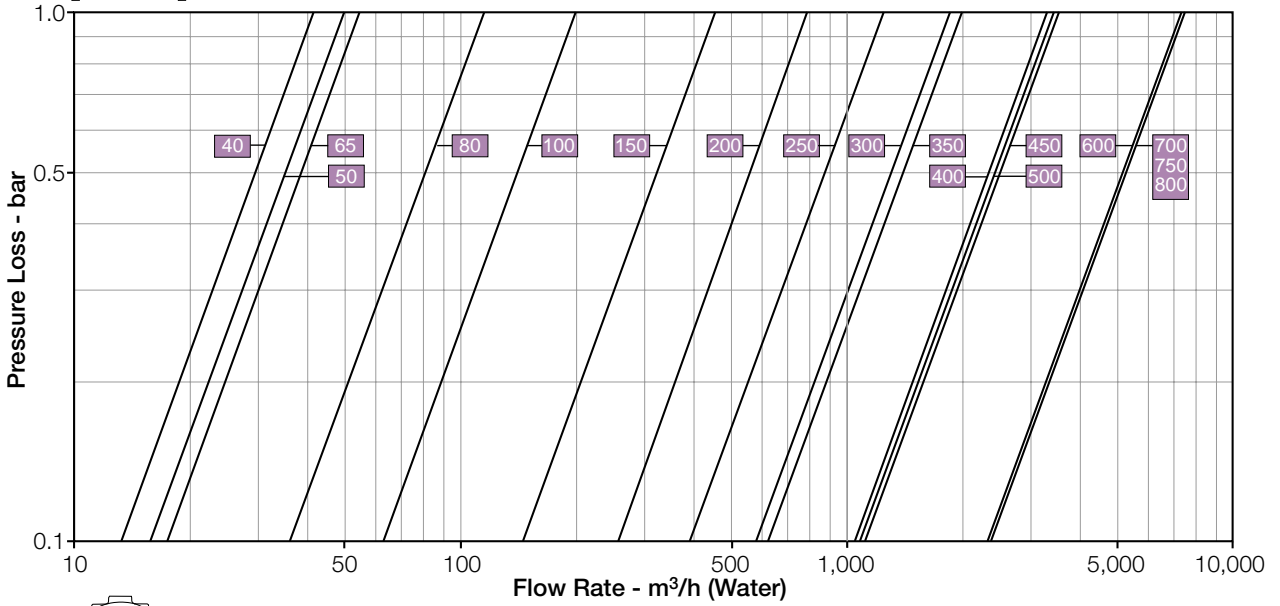

## Angle Pattern, Flat Disc

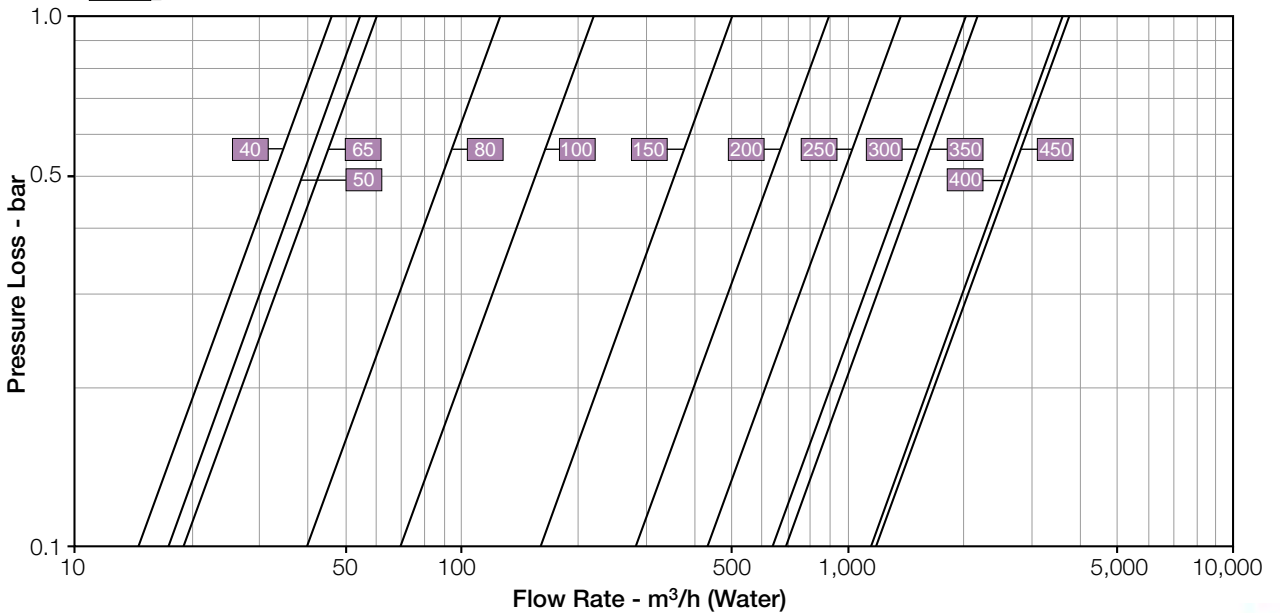



**SI** Metric

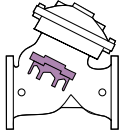

### Y Pattern, Throttling Plug (U-Type)

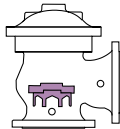
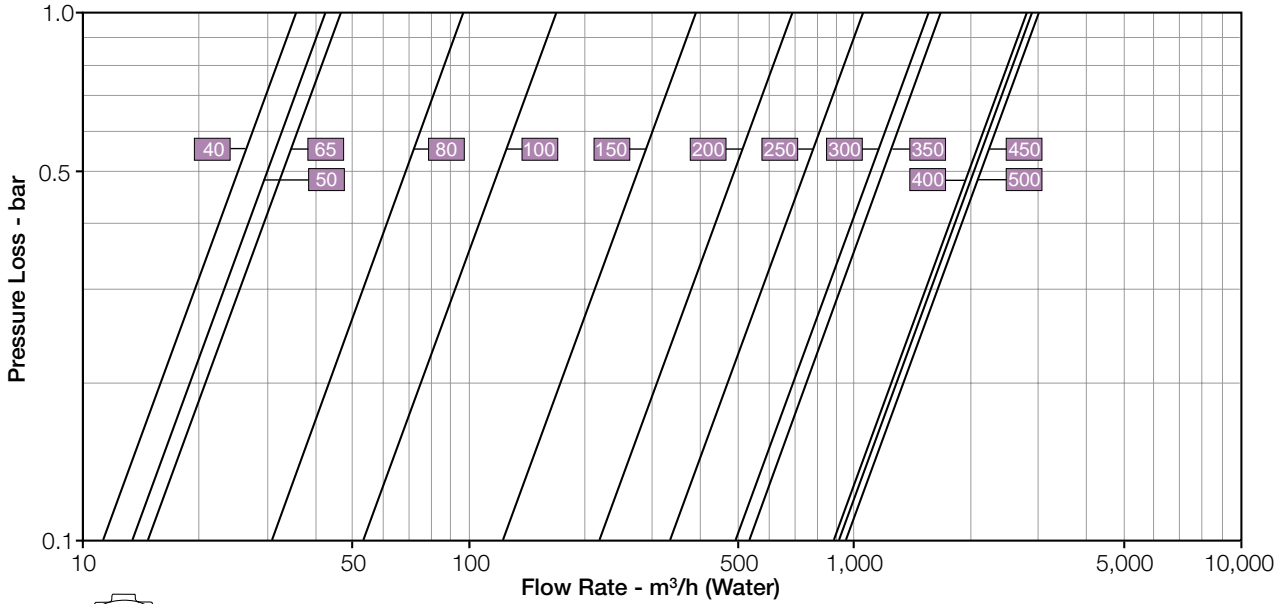

### Angle Pattern, Throttling Plug (U-Type)

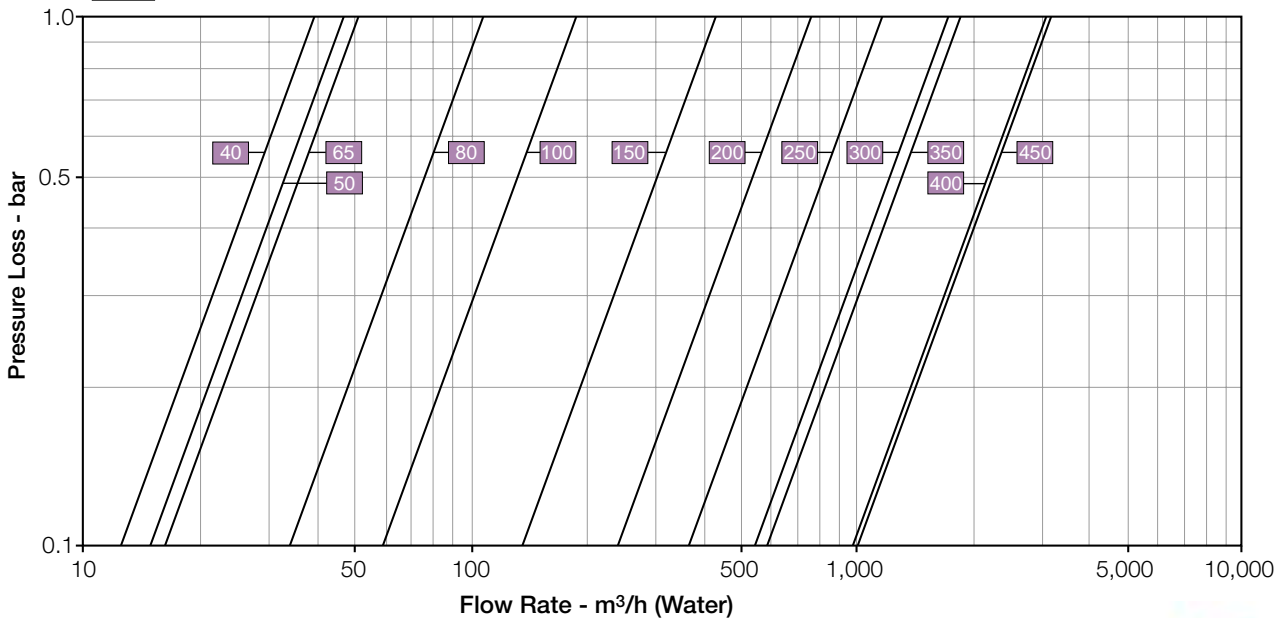



**US** English

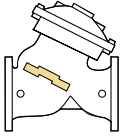

### Y Pattern, Flat Disc

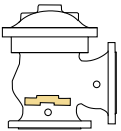
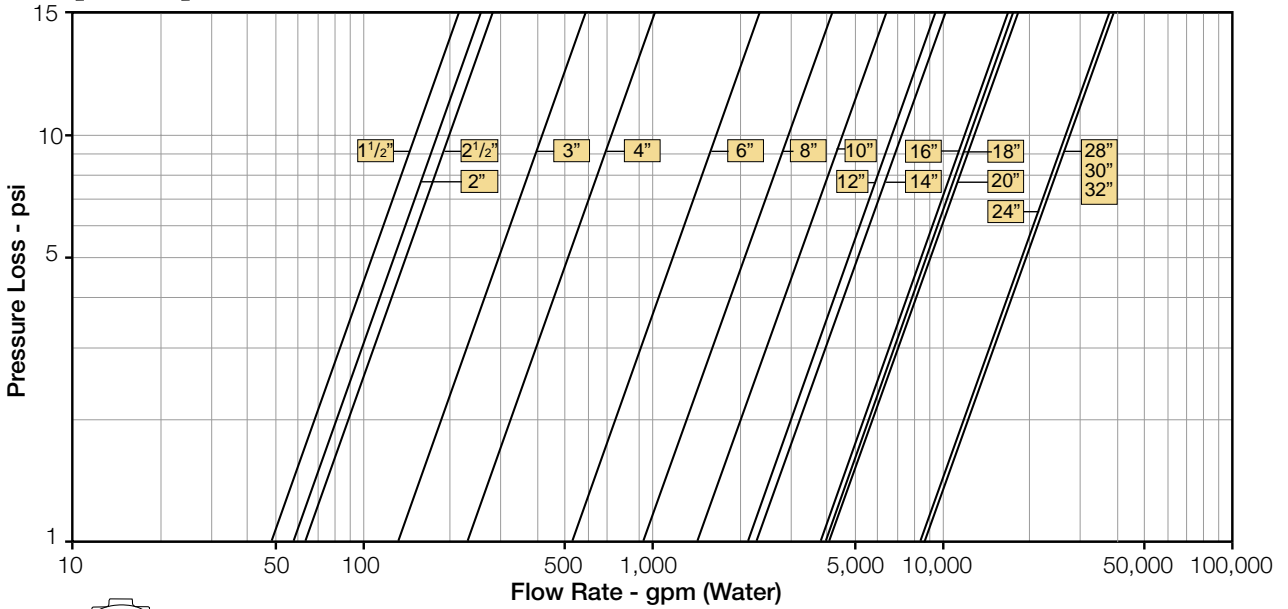

### Angle Pattern, Flat Disc

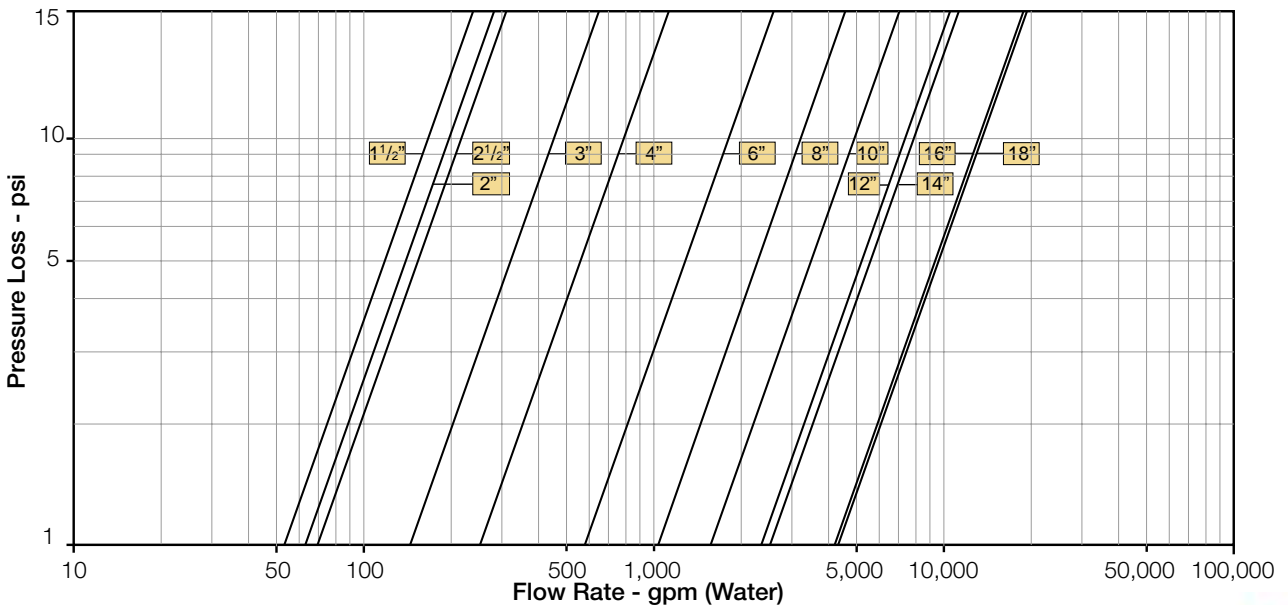



**US** English

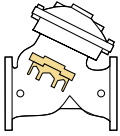

## Y Pattern, Throttling Plug (U-Type)

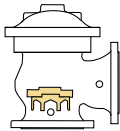
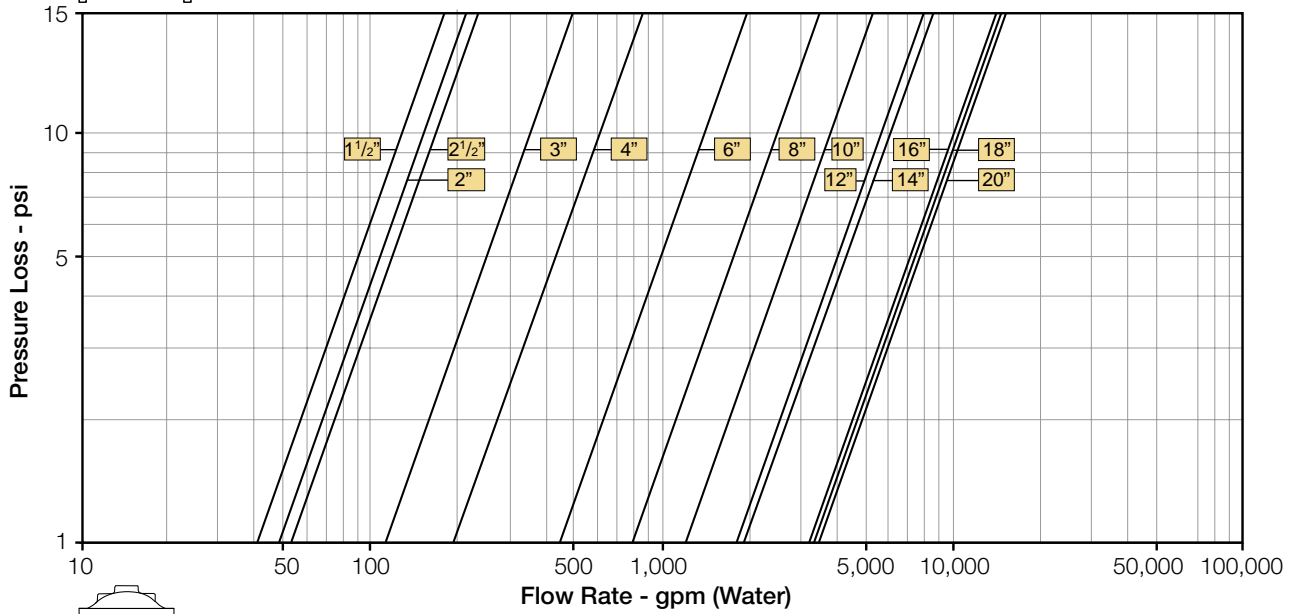

## Angle Pattern, Throttling Plug (U-Type)

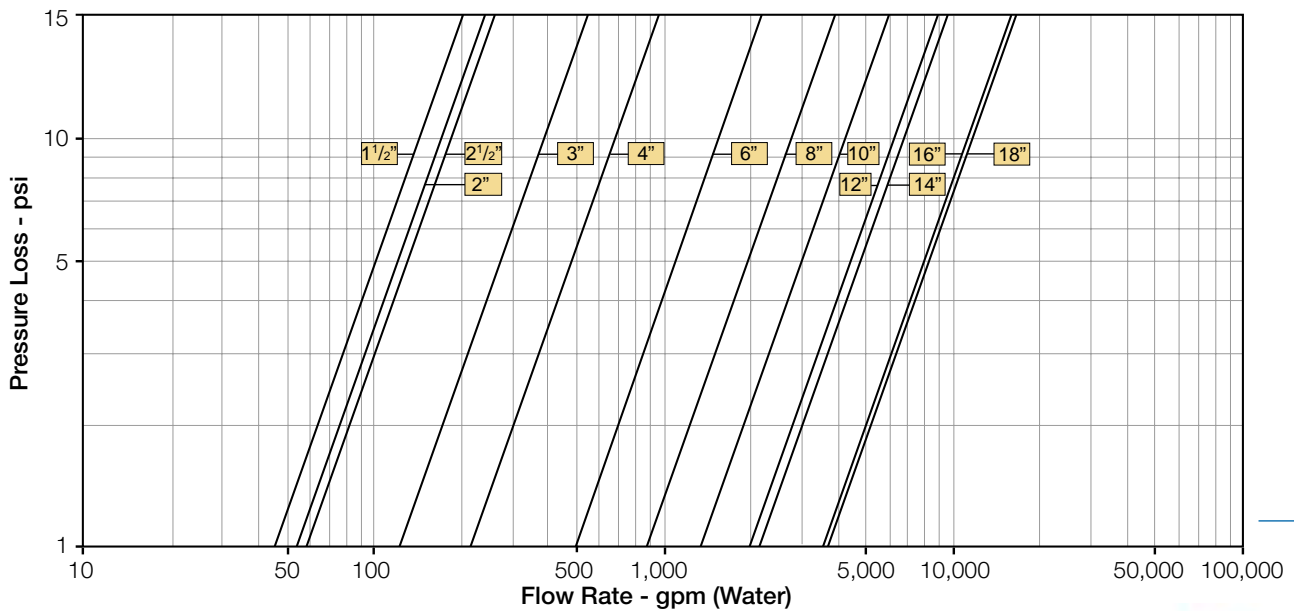



## Cavitation

### Cavitation Guide

**SI** Metric

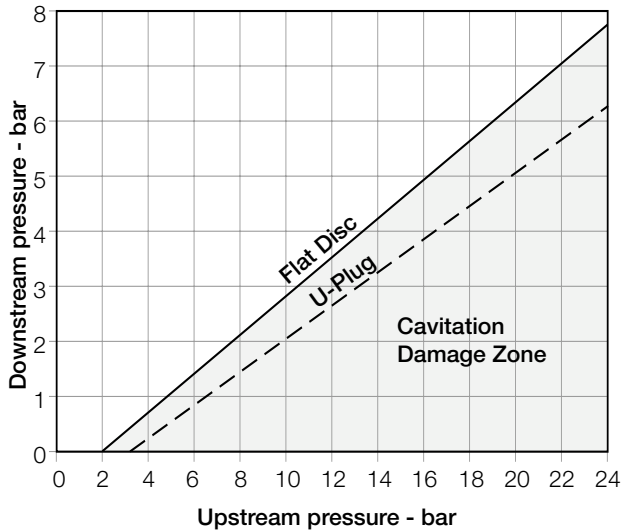

### Cavitation Guide

**US** English

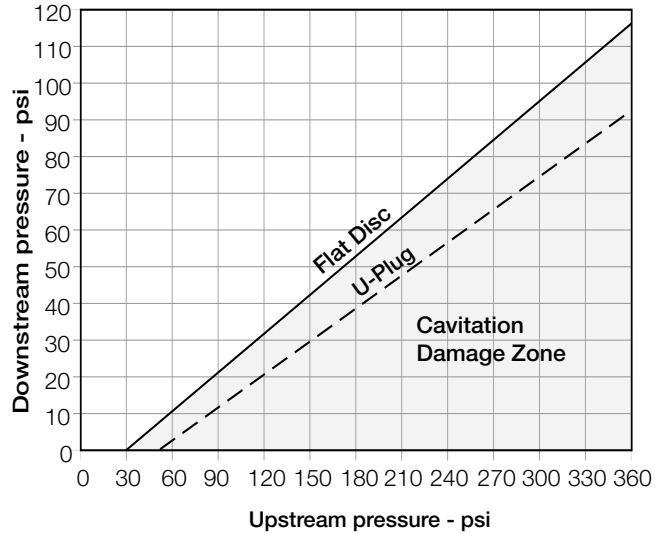

## Cavitation

The cavitation phenomenon has a significant affect on control valve and system performance.

Cavitation may damage the valve and piping by the affects of erosion and vibration. Cavitation also generates noise and may limit and ultimately choke the flow.

As the pressure differential across the valve increases, the static pressure of the flow passing through the throttling area of the valve (Vena Contracta) drops sharply.

When the fluid's static pressure reaches liquid vapor pressure, vapor cavities (bubbles) form and grow until they violently implode by the recovered pressure downstream to the valve seat.

The implosion of these cavities generates high-pressure surges, micro jets and intensive heat, which erode valve components and downstream piping. In its final stage, cavitation flashes and chokes the flow.

The above Cavitation Guides for Bermad 700 Series valves are based on the formula commonly used in the valve industry:

$$\sigma = (P2 - Pv) / (P1 - P2)$$

Where:

$\sigma$  = Sigma, cavitation index, dimensionless

P1 = Upstream pressure, absolute

P2 = Downstream pressure, absolute

Pv = Liquid vapor pressure, absolute

(Water, 18°C = 0.02 bar-a ; 65°F = 0.3 psi-a)

Use these guides and your applications upstream and downstream pressures to determine whether their intersection lies in or out of the cavitation damage zone.

Considerations to avoid cavitation damage:

- A) Reduce system pressure in stages designing each pressure stage to be above cavitation conditions.
- B) Consider using other valve selection criteria
  - a. Valve body and plug type
  - b. Valve size
  - c. Valve material

### Notes:

1. An alternate cavitation index formula introduced by ISA is:  

$$\sigma_{ISA} = (P1 - Pv) / (P1 - P2)$$
 which equals  $\sigma + 1$
2. The above charts should be considered only as a general guide.
3. For optimum system and control valve application please consult Bermad.















### Practical Hydraulic Data

### 700 Series

#### SI Metric

		mm	40	50	65	80	100	150	200	250	300	350	400	450	500
Y-Pattern Flat Disc 	Kv	42	50	55	115	200	460	815	1,250	1,850	1,990	3,310	3,430	3,550	
	K	2.3	3.9	9.2	4.9	3.9	3.7	3.8	3.9	3.7	5.9	3.7	5.5	7.8	
	Leq - m	4.3	10.3	33.4	21.6	23.0	37.5	53.9	70.0	85.6	159.9	112.7	204.8	323.8	
Y-Pattern U-Plug 	Kv	36	43	47	98	170	391	693	1,063	1,573	1,692	2,814	2,916	3,018	
	K	3.1	5.4	12.8	6.7	5.4	5.2	5.2	5.4	5.1	8.2	5.1	7.6	10.8	
	Leq - m	6.0	14.3	46.2	29.9	31.9	51.9	74.6	96.8	118.4	221.3	155.9	283.5	448.1	
Angle Pattern Flat Disc 	Kv	46	55	61	127	220	506	897	1,375	2,035	2,189	3,641	3,773	NA	
	K	1.9	3.2	7.6	4.0	3.2	3.1	3.1	3.2	3.1	4.9	3.0	4.5	NA	
	Leq - m	3.6	8.5	27.6	17.8	19.0	31.0	44.6	57.8	70.7	132.1	93.1	169.3	NA	
Angle Pattern U-Plug 	Kv	39	47	51	108	187	430	762	1,169	1,730	1,861	3,095	3,207	NA	
	K	2.6	4.5	10.6	5.6	4.5	4.3	4.3	4.5	4.2	6.8	4.2	6.2	NA	
	Leq - m	5.0	11.8	38.2	24.7	26.4	42.9	61.7	80.0	97.9	182.9	128.9	234.3	NA	

#### US English

		inch	1.5"	2"	2.5"	3"	4"	6"	8"	10"	12"	14"	16"	18"	20"
Y-Pattern Flat Disc 	Cv	49	58	64	133	230	530	940	1,440	2,140	2,300	3,820	3,960	4,100	
	K	2.3	3.9	9.2	4.9	3.9	3.7	3.8	3.9	3.7	5.9	3.7	5.5	7.8	
	Leq-feet	14.2	33.8	109.5	70.8	75.6	123.0	176.9	229.5	280.8	524.5	369.6	671.9	1,062.3	
Y-Pattern U-Plug 	Cv	41	49	54	113	200	450	800	1,230	1,820	1,950	3,250	3,370	3,490	
	K	3.1	5.4	12.8	6.7	5.4	5.2	5.2	5.4	5.1	8.2	5.1	7.6	10.8	
	Leq-feet	19.7	46.8	151.6	97.9	104.6	170.2	244.8	317.6	388.6	725.9	511.6	930.0	1,470.3	
Angle Pattern Flat Disc 	Cv	53	64	70	146	250	580	1,040	1,590	2,350	2,530	4,210	4,360	NA	
	K	1.9	3.2	7.6	4.0	3.2	3.1	3.1	3.2	3.1	4.9	3.0	4.5	NA	
	Leq-feet	11.7	28.0	90.5	58.5	62.5	101.6	146.2	189.7	232.0	433.4	305.5	555.3	NA	
Angle Pattern U-Plug 	Cv	45	54	59	124	220	500	880	1,350	2,000	2,150	3,580	3,710	NA	
	K	2.6	4.5	10.6	5.6	4.5	4.3	4.3	4.5	4.2	6.8	4.2	6.2	NA	
	Leq-feet	16.3	38.7	125.3	80.9	86.5	140.7	202.4	262.5	321.2	599.9	422.8	768.6	NA	

#### SI Metric

		mm	600	700	750	800
G-Pattern Flat Disc 	Kv	7,350	7,500	7,500	7,500	
	K	3.8	6.7	8.8	11.4	
	Leq - m	188.0	390.1	550.9	760.7	

#### US English

		inch	24"	28"	30"	32"
G-Pattern Flat Disc 	Cv	8,490	8,670	8,670	8,670	
	K	3.8	6.7	8.8	11.4	
	Leq-feet	616.6	1,280.0	1,807.3	2,495.6	

Valve flow coefficient, Kv or Cv

$$Kv(Cv) = Q \sqrt{\frac{Gr}{\Delta P}}$$

Where:

Kv = Valve flow coefficient (flow in m<sup>3</sup>/h at 1bar Diff. Press.)

Cv = Valve flow coefficient (flow in gpm at Diff. Press. 1psi)

Q = Flow rate (m<sup>3</sup>/h ; gpm)

ΔP = Differential pressure (bar ; psi)

Gr = Liquid specific gravity (Water = 1.0)

$$Cv = 1.155 Kv$$

Flow resistance or Head loss coefficient,  $K = \Delta H \frac{2g}{V^2}$

Where:

K = Flow resistance or Head loss coefficient (dimensionless)

ΔH = Head loss (m ; feet)

V = Nominal size flow velocity (m/sec ; feet/sec.)

g = Acceleration of gravity (9.81 m/sec<sup>2</sup> ; 32.18 feet/sec<sup>2</sup>)

Equivalent Pipe Length, Leq

Leq = Lk · D

Where:

Leq = Equivalent nominal pipe length (m ; feet)

Lk = Equivalent length coefficient for turbulent flow in clean commercial steel pipe (SCH 40)

D = Nominal pipe diameter (m ; feet)

Note:

The Leq values given are for general consideration only.

Actual Leq may vary somewhat with each of the valve sizes.





## Valve Plugs Characteristics

Kv ; Cv to Valve Opening Chart

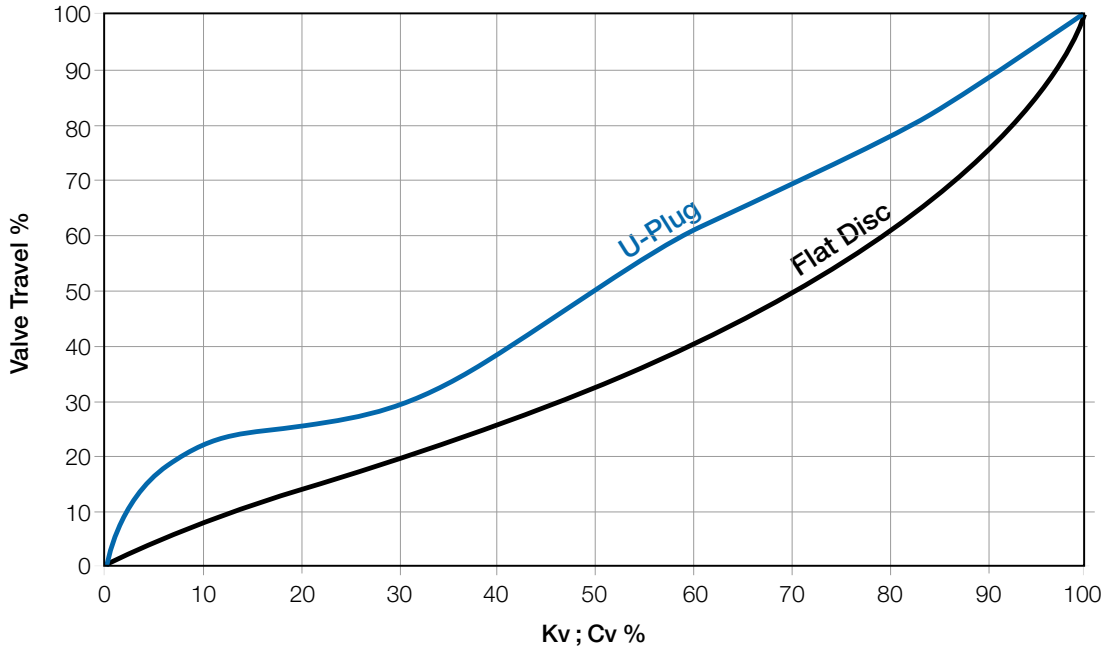

## Typical Pressure Reducing Performance Chart

Actual Hydraulic Laboratory Results

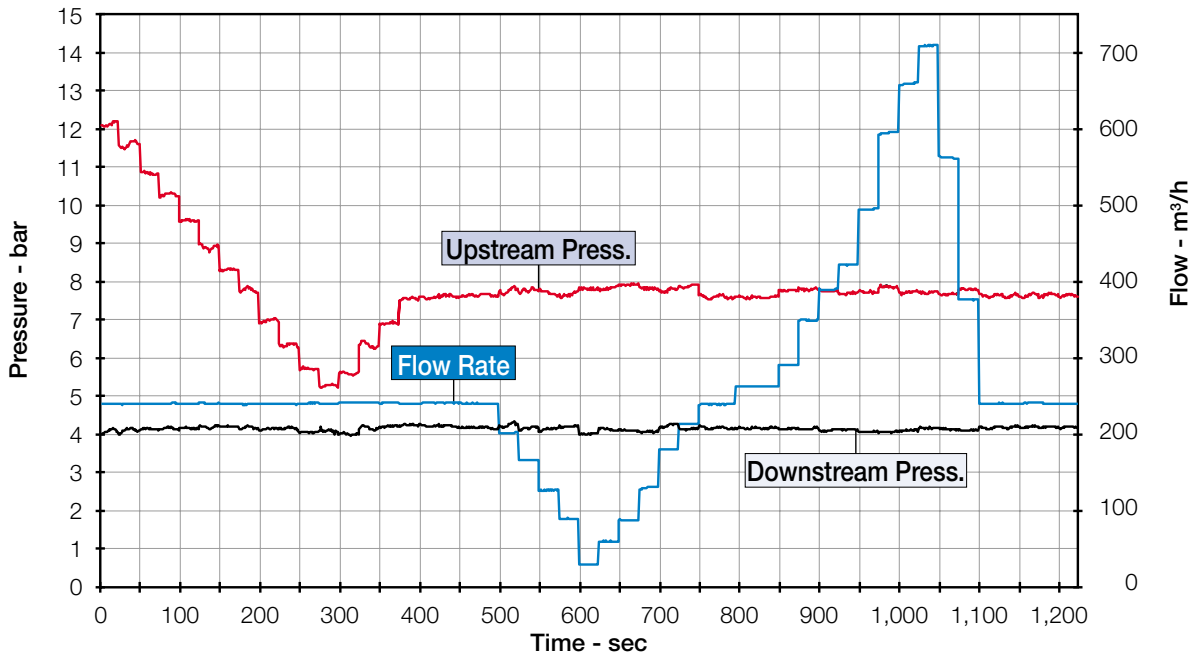

# Engineering

## BERMAD Engineering



[bermad@bermadusa.com](mailto:bermad@bermadusa.com) • [www.bermad.com](http://www.bermad.com)

BERMAD Inc., 4070 Leaverton Court, Anaheim, CA 92807 Tel: 800-821-6825, 714-666-1100, Fax: 714-666-2533

PT7XE02 04