

Pneumatically Operated, Remote Controlled Monitor Valve

Model: FP 400E-4X



Description

The Bermad Remote Controlled On-Off valves replace motor driven valves or actuated quarter turn valves. They are especially suitable for oscillating or remote controlled Monitors, and for installation in modern foam systems where a shut-off function is required. The Pneumatically actuation provides maximum safety also in seawater and foam concentrate applications.

Typical Applications

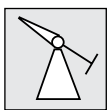

Remote monitor

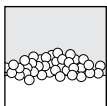

Foam systems



Zone isolating, on-off remote control

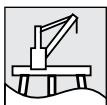

Offshore platforms / marine vessels



Sea water/corrosive water supplies

Features and Benefits

- **3-Way control system** – Avoids continuous releasing
- **Smooth opening and closing characteristics** – Prevents water surge
- **One-piece molded elastomeric moving part** – No maintenance required
- **Quick cover removal** – Minimal downtime

Optional Features

- **Seawater service** (add FS as prefix to model)
- **Foam concentrate service** (add FC as prefix to model)
- **Electric indication** (Limit Switch or Pressure Switch)
- **Valve Position Single/Double Limit Switches**

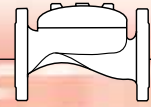

Operation

The Model FP 400E-4X is an on/off pneumatically remote controlled valve designed to open and close drip-tight in response to an external pneumatic pressure command. It is a line pressure driven, diaphragm actuated globe valve, which harnesses line pressure [1] to develop maximum hydraulic power. Dry pilot line pneumatic pressure [2] is applied, to a 3-Way Relay Valve (HRV-3) [3], opening it. Through the override cock valve [4], the HRV-3 applies upstream pressure to the valve's control chamber [5] closing the main valve drip tight.

Under FIRE condition, a dry pilot line pneumatic pressure drop, closes the HRV-3, which then vents the valve's control chamber allowing the main valve to open.

The Check Valve [6] traps high pressure peaks, ensuring that the valve remains locked in the closed position to maintain drip-tight sealing.

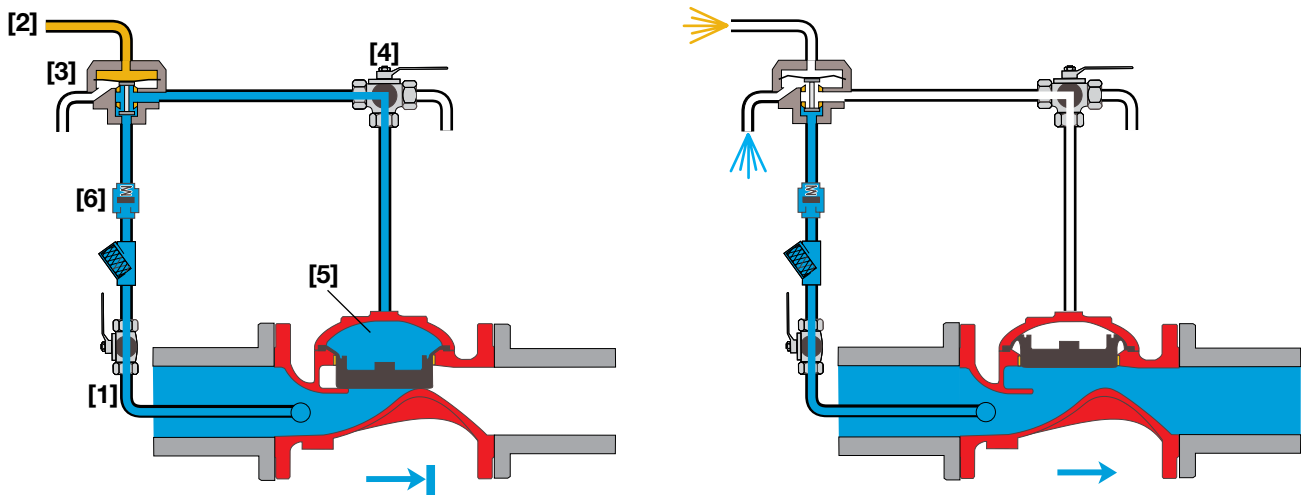

Valve Closed (set position)

Valve Open (operating condition)

Engineer Specifications

- The valve shall be pneumatically operated elastomeric type globe valve with a **rolling-diaphragm**.
- The valve shall have an **unobstructed flow path**, with no stem guide or **supporting ribs**.
- Valve actuation shall be accomplished by a fully peripherally supported, one-piece balanced rolling-diaphragm, vulcanized with a rugged radial seal disk. The diaphragm assembly shall be the only moving part.
- The valve shall have a removable cover for quick in-line service enabling all necessary inspection and servicing.
- The control trim shall consist of non-corrosive tubing and fittings, and plated brass accessories, including 3-way Relay Valve (HRV-3), Y strainer, 3-Way Manual Override Valve and check valve.
- The control trim shall be supplied as an assembly, pre-assembled and hydraulically tested at an ISO 9000 and 9001 certified factory.
- The Pneumatically Controlled Valve shall open and close in response to a dry pilot line pneumatic pressure drop.

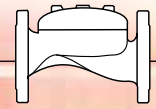

Remote Controlled Monitor System (with Foam Concentrate Injection)

System Components

- 1 - BERMAD Model FP 400E-4X
- 2 - Bermad Model FC 400E-4X Foam Concentrate Valve
- 3 - Remote Controlled Monitor
- 4 - Pneumatic Control Panel

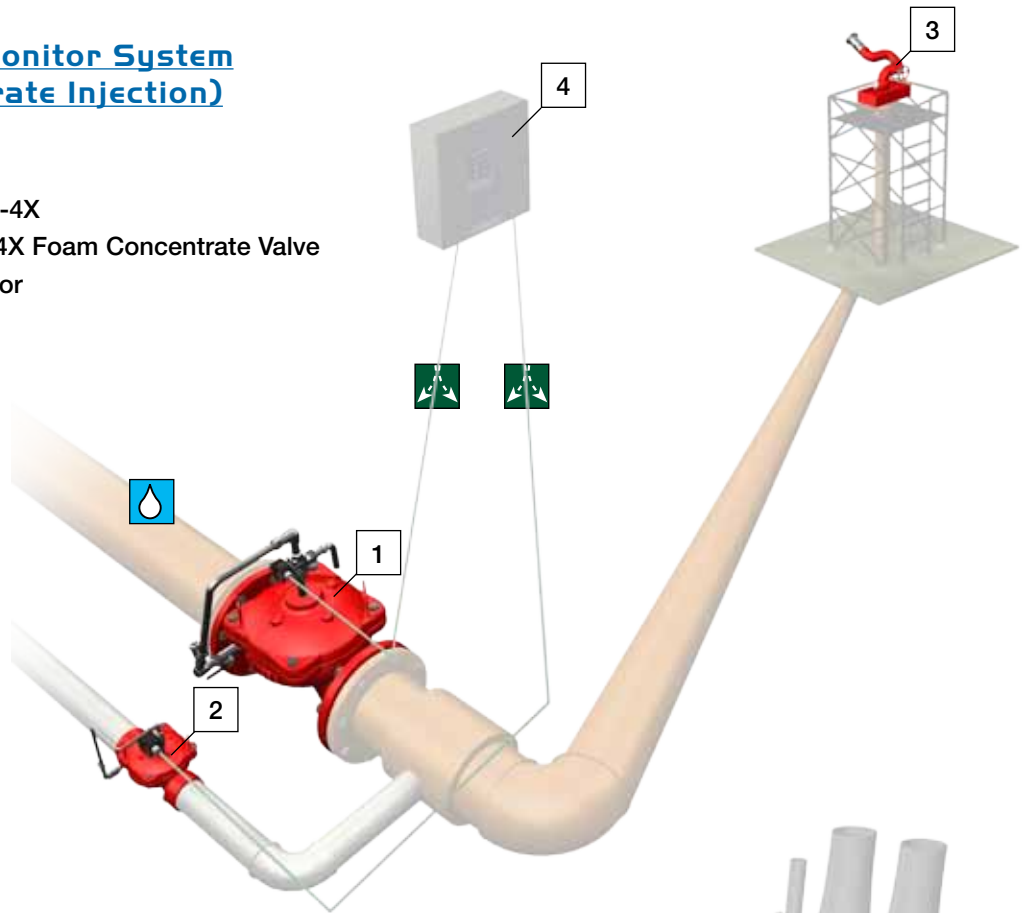

Emergency Zone Isolation System

System Components

- 1 - BERMAD FP 400E Deluge Valve
- 2 - Bermad Model FP 400E-4X Remote Controlled Shut-off Valve
- 3 - Deluge Spray System
- 4 - Pneumatic Control Panel

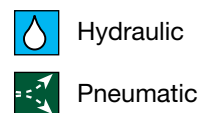
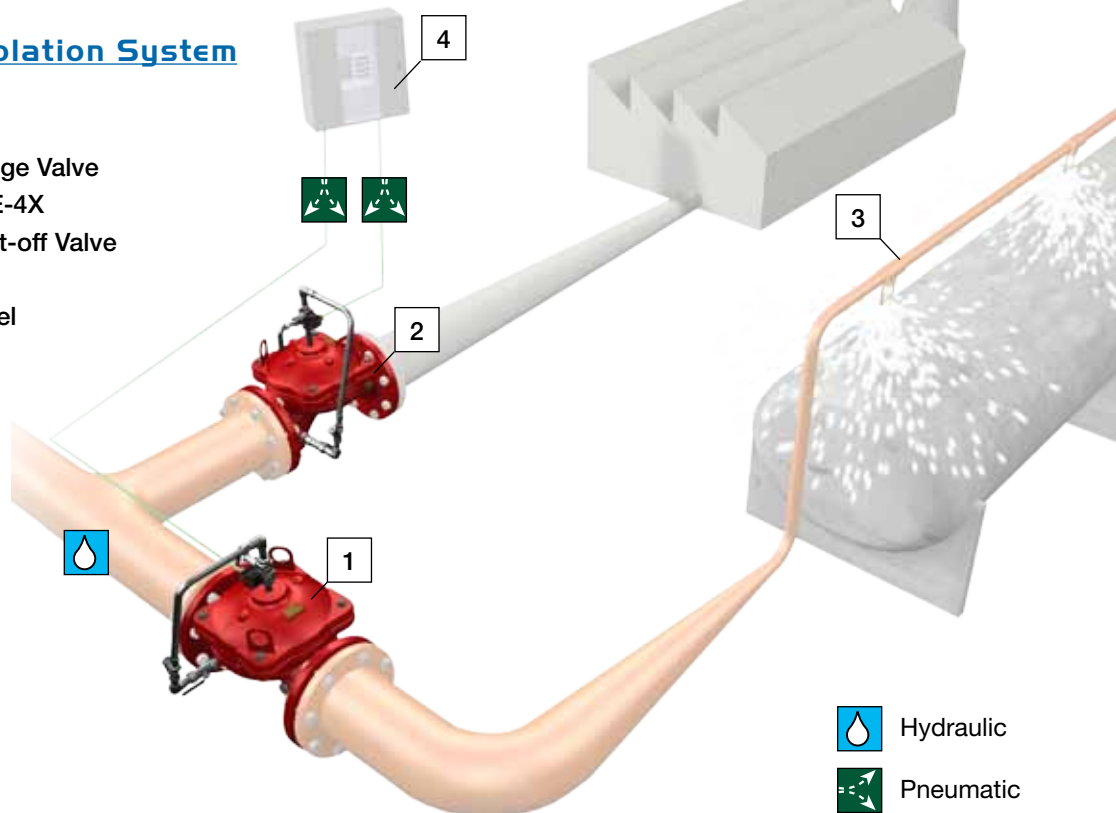

BERMAD Fire Protection

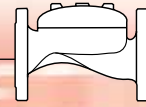

Model: FP 400E-4X

400 Series

Technical Data

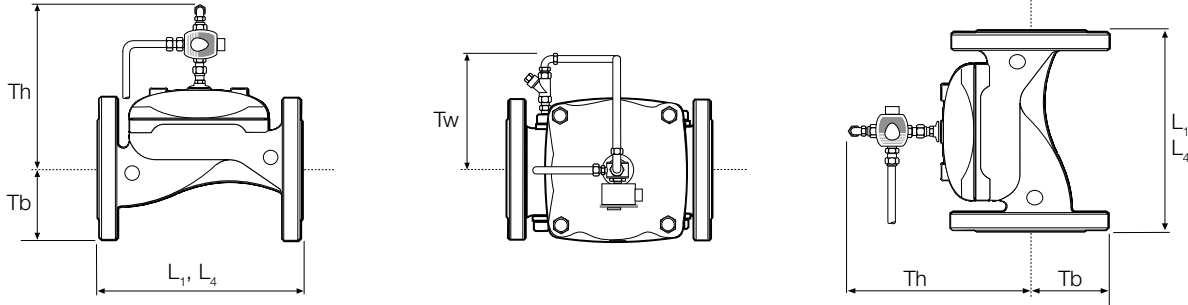

Size	1½"		2"		2½"		3"		4"		6"		8"		10"		12"		
	mm	inch	mm	inch	mm	inch	mm	inch	mm	inch	mm	inch	mm	inch	mm	inch	mm	inch	
Dimensions	L ₁ ⁽¹⁾	205	8 ¹ / ₁₆	205	8 ¹ / ₁₆	205	8 ¹ / ₁₆	257	10 ² / ₁₆	320	12 ¹⁰ / ₁₆	415	16 ⁵ / ₁₆	500	19 ¹¹ / ₁₆	607	23 ¹⁴ / ₁₆	725	28 ⁹ / ₁₆
	L ₄ ⁽²⁾	205	8 ¹ / ₁₆	205	8 ¹ / ₁₆	N/A	N/A	257	10 ² / ₁₆	320	12 ¹⁰ / ₁₆	N/A	N/A	500	19 ¹¹ / ₁₆	N/A	N/A	N/A	N/A
	Tw	255	10 ¹ / ₁₆	255	10 ¹ / ₁₆	255	10 ¹ / ₁₆	255	10 ¹ / ₁₆	255	10 ¹ / ₁₆	255	10 ¹ / ₁₆	255	10 ¹ / ₁₆	255	10 ¹ / ₁₆	255	10 ¹ / ₁₆
	Tb	64	2 ⁸ / ₁₆	78	3 ¹ / ₁₆	89	3 ⁸ / ₁₆	100	3 ¹⁵ / ₁₆	115	4 ⁸ / ₁₆	140	5 ⁸ / ₁₆	172	6 ¹² / ₁₆	204	8 ¹ / ₁₆	242	9 ⁸ / ₁₆
	Th	289	11 ⁶ / ₁₆	289	11 ⁶ / ₁₆	301	11 ¹⁴ / ₁₆	325	12 ¹³ / ₁₆	345	13 ⁹ / ₁₆	420	16 ⁹ / ₁₆	471	18 ⁹ / ₁₆	471	18 ⁹ / ₁₆	588	23 ² / ₁₆

- Notes:**
- L₁ is for flanged ANSI #150 and ISO PN16.
 - L₄ is for grooved end connections (Ductile Iron Only).
 - Provide adequate space around valve for maintenance.
 - Data is for envelope dimensions, specific component positioning may vary.

Connection Standard

- Flanged: ANSI B16.42 (Ductile Iron), B16.5 (Steel & Stainless Steel), B16.24 (Bronze)
- ISO PN16
- Grooved: ANSI/AWWA C606 for 2, 3, 4, 6 & 8"

Water Temperature

- 0.5 – 50°C (33 – 122°F)

Available Sizes

- 1½, 2, 2½, 3, 4, 6, 8, 10 & 12"

Pressure Rating

- Max. working pressure: 250 psi (17 bar)

Air Pressure supply

- Valve opens on pneumatic pressure drop
- Minimum Pneumatic pressure – 5 bar
- Pneumatic Pilot line must be continually pressurized to keep the main valve closed.
- Optional: Fail Safe Close (pressure to open)

Manufacturers Standard Materials

Main valve body and cover

- Ductile Iron ASTM A-536

Main valve internals

- Stainless Steel & Elastomer

Control Trim System

- Brass control components/accessories
- Stainless Steel 316 tubing & fittings

Elastomers

- Polyamide fabric reinforced Polyisoprene, NR

Coating

- Electrostatic Powder Coating Polyester, Red (RAL 3002)

Optional Materials

Main valve body

- Carbon Steel ASTM A-216 WCB
- Stainless Steel 316
- Ni-Al-Bronze ASTM B-148

Control Trim

- Stainless Steel 316
- Monel® and Al-Bronze
- Hastelloy C-276

Elastomers

- NBR
- EPDM

Coating

- High Build Epoxy Fusion-Bonded with UV Protection, Anti-Corrosion



bermadfire@bermad.com • www.bermad.com

The information herein is subject to change without notice. BERMAD shall not be held liable for any errors. All rights reserved. © Copyright by BERMAD. PE4PE-4X 11